

**ALEX SOUZA LIRA**

**APLICAÇÃO DE MODELOS TRÓFICOS EM UM ESTUÁRIO TROPICAL: UM  
ESTUDO DE CASO EM PERNAMBUCO**

**RECIFE**

**2017**



**UNIVERSIDADE FEDERAL RURAL DE PERNAMBUCO  
PRÓ-REITORIA DE PESQUISA E PÓS-GRADUAÇÃO PROGRAMA DE PÓS-GRADUAÇÃO  
EM RECURSOS PESQUEIROS E AQUICULTURA**

**APLICAÇÃO DE MODELOS TRÓFICOS EM UM ESTUÁRIO TROPICAL: UM  
ESTUDO DE CASO EM PERNAMBUCO**

**Alex Souza Lira**

Dissertação apresentada ao Programa de Pós-Graduação em Recursos Pesqueiros e Aquicultura da Universidade Federal Rural de Pernambuco como exigência para obtenção do título de Mestre.

**Prof.<sup>a</sup> Dr.<sup>a</sup> Flávia Lucena Frédou**  
Orientador

**Prof. Dr. Ronaldo Angelini (UFRN)**  
Co-orientador

**Prof. Dr. François Le Loc'h (IRD-França)**  
Co-orientador

Recife, Fevereiro/2017

Dados Internacionais de Catalogação na Publicação (CIP)  
Sistema Integrado de Bibliotecas da UFRPE  
Biblioteca Central, Recife-PE, Brasil

L768a Lira, Alex Souza  
Aplicação de modelos tróficos em um estuário tropical: um estudo de caso em Pernambuco / Alex Souza Lira. – 2017.  
96 f.: il.

Orientadora: Flávia Lucena Frédou.  
Coorientadores: Ronaldo Angelini, François Le Loc'h.  
Dissertação (Mestrado) – Universidade Federal Rural de Pernambuco, Programa de Pós-Graduação em Recursos Pesqueiros e Aquicultura, Recife, BR-PE, 2017.  
Inclui referências, anexo(s) e apêndice(s).

1. EwE 2. Rede trófica 3. Indicadores ecológicos 4. Espécies chave 5. *Centropomus* spp I. Frédou, Flávia Lucena, orient.  
II. Angelini, Ronaldo, coorient. III. Le Loc'h, François, coorient.  
IV. Título

CDD 639.3

**UNIVERSIDADE FEDERAL RURAL DE PERNAMBUCO**  
**PRÓ-REITORIA DE PESQUISA E PÓS-GRADUAÇÃO PROGRAMA DE PÓS-GRADUAÇÃO**  
**EM RECURSOS PESQUEIROS E AQUICULTURA**

**APLICAÇÃO DE MODELOS TRÓFICOS EM UM ESTUÁRIO TROPICAL: UM**  
**ESTUDO DE CASO EM PERNAMBUCO**

**Alex Souza Lira**

---

**Prof.<sup>a</sup> Dr<sup>a</sup> Flávia Lucena Frédou**  
Orientadora

Departamento de Pesca/Universidade Federal Rural de Pernambuco

---

**Prof. Dr. Humber Agreli Andrade**  
Membro Interno

Departamento de Pesca/Universidade Federal Rural de Pernambuco

---

**Profa. Dra. Beatrice Padovani**  
Membro Externo

Departamento Oceanografia/Universidade Federal de Pernambuco

## **Dedicatória**

Aos meus pais, Alaide Souza Lira e Caetano Correia Lira.

## Agradecimentos

Primeiramente a Deus, pois sem ele nada é possível.

Agradeço aos meus pais Alaide Souza Lira e Caetano Correia Lira, por serem os principais responsáveis pela realização desse sonho. Aos meus irmãos Mariana Souza Lira e Cicero Pedro De Albuquerque Filho. Amo vocês.

Agradeço a toda minha família, Tias e Tios, Primos e Primas, pela credibilidade e confiança.

Agradeço a minha namora Ítala Gabriela Sobral Dos Santos, por todo amor, cumplicidade, confiança e companheirismo. Te amo meu amor. Ao meu sogro, sogra e cunhada por terem me acolhido tão bem em sua família.

Agradeço aos Professores Thierry Frédou e Flávia Lucena Frédou, pela oportunidade de trabalhar junto a eles, pela paciência, orientação e amizade.

Aos meus co-orientadores François Le Loc'h e Ronaldo Angelini por toda a ajuda neste trabalho.

A todos os antigos e atuais componentes do laboratório BIOIMPACT, em especial a Valdimere, Júlio, Gary, Leandro a quem a convivência nos últimos anos tem sido maravilhosa.

A todos os funcionários do Departamento de Pesca e Aquicultura, sempre atentos e procurando ajudar.

Aos professores que contribuíram para minha formação atual.

Aos meus amigos e irmãos. Em especial aos meus amigos Mondrian Sales e Carlos Henrique.

À UFRPE, por ser minha segunda casa nesses últimos 2 anos de pós graduação.

À CAPES, pela concessão da bolsa de mestrado

Obrigados a todos, sem vocês este sonho não seria possível

“If you have a dream shall protect”

Alex Souza Lira

## Resumo

A abordagem Ecopath with Ecosim foi usada para descrever a estrutura e as interações da rede trófica e avaliar o efeito da pesca na rede trófica de um estuário tropical no Nordeste do Brasil (Estuário do Rio Sirinhaém – ESR). Para a construção do modelo Ecopath foram amostradas espécies de peixes e macroinvertebrados, entre 2013-2014, enquanto dados de produtividade primária e zooplâncton foram obtidos através da literatura. Os resultados mostraram que a transferência de energia na rede trófica do ESR foi baseada na produtividade primária (60,5%), com uma média de transferência de 6,79%, relativamente baixa quando comparada com o valor teórico de 10%, indicando uma baixa eficiência global de transferência, embora dentro dos valores reportados para vários modelos tróficos de estuários. O índice de espécie-chave e a análise de impacto trófico indicaram que o Camurim (*Centropomus* spp.), com nível trófico = 3,20, é um componente-chave no sistema, podendo desencadear um efeito cascata (top-down). O aumento da atividade de pesca causa uma redução da biomassa do Camurim, e conseqüentemente diminui a pressão de predação nas suas presas. Os indicadores ecológicos para a saúde do ecossistema indicam que ESR é um sistema em desenvolvimento, como a maioria dos estuários, demandando estratégias de manejo para a manutenção do estado de equilíbrio. Este estudo fornece as primeiras informações para descrever e avaliar o estado da rede trófica em um ecossistema estuarino tropical no nordeste do Brasil.

**Palavras-chave:** EwE, Rede Trófica, Indicadores Ecológicos, Espécies-Chave, *Centropomus* spp.

## Abstract

The ecosystem approach Ecopath with Ecosim was used to describe the food web structure, and to evaluate the fishing effects in a tropical estuary ecosystem in northeastern Brazil (Estuary of the Sirinhaém River – SRE). To build the Ecopath model we sampled fish species and macroinvertebrates between 2013-2014, while data of primary production and zooplankton were obtained from literature. Results showed that the energy transfer in the SRE food web was based mostly on grazing food chain (60.5%), with an average transfer efficiency of 6.79%, relatively low compared to the theoretical value of 10%, indicating low global transfer efficiency, although it is within the range reported in various estuarine trophic models. The keystone index together with the MTI (Mixed Trophic Impact) index indicated the snook (*Centropomus* spp.), with Trophic Level = 3.20, as a key component in the system, which could trigger a cascade effect (top-down). The increasing in the fishery activity causes a reduction in the Snook biomass, and consequently decrease the pressure of predation on their prey. The ecological indicators of ecosystem health indicated that the SRE is a system in development, as most estuaries, requiring management strategies to the maintenance for the equilibrium state. This study provides the first information to describe and evaluate the state of food web in a tropical estuarine ecosystem in Northeast Brazil.

**Keywords:** EwE, Food web, Ecological indicators, Keystone species, *Centropomus* spp



## Lista de figuras

- Figure 1 Estuary of Sirinhaém River, Northeast Brazil, the sampling points of this study carried out between 2013 and 2014 and the area of model. .... 27*
- Figure 2 Scheme of the 12 simulations, which represent 20-year of scenarios increasing and decreasing fishing mortality for all species target fishing in the Estuary of Sirinhaém River, Northeast Brazil. .... 33*
- Figure 3 Fish composition of fish, expressed in % in weight; captured with manual beach seine in the Estuary of Sirinhaém River, Northeast Brazil. .... 35*
- Figure 4 Schematic diagram of energy flow representing the food web structure of the Estuary of Sirinhaém River, Northeast Brazil. The color lines denote energetic flow from a group to other (Red – High flow and White – Low flow). Different sizes of the circles indicate the different biomass ( $t\ km^{-2}$ ) of the components into trophic levels 1, 2, 3 and 4. .... 38*
- Figure 5 Trophic flows of the Estuary of Sirinhaém River, Northeast Brazil by integer trophic levels (TL) in the form of Lindeman spine. P and D represent the primary production and detritus respectively, while the values in boxes indicate the biomass, import and percentage of total system throughput (TST) for each trophic level (TL). The values above and below arrows exhibit the efficiency of energy transfer (TE) through each trophic level. .... 39*
- Figure 6 Mixed trophic impact (MTI) of the Estuary of Sirinhaém River, Northeast Brazil. The color box shows negative (red) or positive (blue) impacts on the functional groups. The intensity of the color in the box are proportional to the degree of the impacts and its values ranges from  $-1$  to  $+1$ . .... 40*
- Figure 7 (a) Keystone index (axis Y) and relative total impact (axis X) of each compartment of the the Estuary of Sirinhaém River, Northeast Brazil. (b) Relationship between relative total impact (axis Y) and relative biomass (axis X). Number and circle size indicates the name and percentage relative biomass of each group. \* Conceptual identification of keystone species in food-web (VALLS et al., 2015). .... 41*
- Figure 8 Changes in the biomass from Ecosim model, for different organisms (Fish, Invertebrates, Primary production – PP and Detritus) between 2014 and 2033 of the Estuary of Sirinhaém River, Northeast Brazil. The black solid line and red dash line correspond to the simulations of increase and decreased of the fishing mortality, respectively. .... 44*
- Figure 9 Ecological indicators (a) L index and (b) probability to be sustainably fished (psust) estimated based on the increase and decrease values of fishing mortality of the Estuary of Sirinhaém River, Northeast Brazil. .... 45*
- Figure 10 (a) Kempton's index and (b) mean trophic level catch (mTLc) estimated from variation of the values of fishing mortality between 2014 and 2033 of the Estuary of*

*Sirinhaém River, Northeast Brazil. The black solid line and red dash line correspond the simulations of increase and decreased fishing mortality, respectively. .... 46*

*Figure 11 Conceptual model of the fishing effect and Snook in Estuary of Sirinhaém River, Northeast Brazil..... 50*

## Lista de tabelas

*Table 1 Taxonomic composition and trophic guilds of each compartment of the model.* 35

*Table 2 Basics inputs and estimated outputs (bold) for the trophic groups for model of the Estuary of Sirinhaém River, Northeast Brazil. TL: trophic level; B: biomass; P/B: production–biomass ratio; Q/B: consumption–biomass ratio; EE: ecotrophic efficiency; P/Q: production–consumption ratio; Y: landings; OI: Omnivory Index; PN: Path Number. Values in bold are estimated from the model.* ..... 36

*Table 3 Diet composition matrix for the functional groups in the Estuary of Sirinhaém River, Northeast Brazil.* ..... 37

*Table 4 Ecosystem attributes, ecological and flow indicators to the food web structure of the Estuary of Sirinhaém River, Northeast Brazil. \* Rate of the Sum of all consumption, exports, respiratory flows and flows into detritus, in relation the Total system throughput.* ..... 43

*Table 5 Estimates of ecological indicators for maintenance of production of the groups on Estuary of Sirinhaém River, Northeast Brazil.* ..... 44

## Sumário

Sumário	
Dedicatória.....	iv
Agradecimentos .....	v
Resumo .....	vi
Abstract.....	vii
Lista de figuras .....	viii
Lista de tabelas .....	x
Sumário.....	xi
1. Introdução .....	11
2. Objetivos.....	13
2.1 Geral .....	13
2.2 Específicos.....	13
3. Referências Bibliográficas.....	14
4. Artigo científico.....	23
4.1 Trophic structure in a neotropical estuary: the study case of Sirinhaém, Northeastern Brazil .....	24
5. Considerações Finais .....	73
6. Anexos.....	74

## 1. Introdução

A partilha de recursos (GUEDES e ARAÚJO, 2008), preferência de habitat (WETHERBEE e CORTÉS, 2004), competição (SVANBÄCK e BOLNICK, 2007) e avaliação do fluxo energético (MODICA et al., 2015) são apenas algumas das temáticas obtidas com os estudos de ecologia trófica, sendo a avaliação holística das interações tróficas entre os diferentes organismos nestes ambientes é fundamental para a compreensão da dinâmica, produtividade e manutenção da sustentabilidade dos ecossistemas (YOUNG et al., 2015). Todas estas informações acerca da ecologia trófica são também consideradas de grande valia no desenvolvimento de estratégias de conservação de espécies e ecossistemas (SIMPENDORFER et al., 2011).

Modelos ecossistêmicos são uma realidade no auxílio de mecanismos de gestão, devido à sua capacidade de inclusão de inúmeras variáveis e processos em diferentes escalas, associados a resultados quantitativos fáceis de interpretar (ROMAGNONI et al., 2015), facilitando tomadas de decisão pela gestão dos ecossistemas (FULTON et al., 2011; DICHMONT et al., 2013). O Ecopath com Ecosim (EwE) é um dos softwares criados para elaboração de modelos ecossistêmicos. Foi desenvolvido inicialmente para estimar biomassa/produção/consumo dos componentes do ecossistema (ECOPATH ) (POLOVINA, 1984) e posteriormente, outras ferramentas adicionais foram incorporadas ao Ecopath, dentre elas, o Ecosim; no qual é possível fazer previsões futuras com base em uma serie temporal (WALTERS et al., 1997); Ecospace, que permite avaliar espacialmente a região modelada (WALTERS et al., 1999) e mais recentemente, “Value-Chain” que faz uma teia econômica dos recursos utilizados (TRAVERS et al., 2007; FULTON, 2010; HALOUANI et al., 2016b).

Atualmente o repositório global de modelos “Ecobase” conta com aproximadamente 571 modelos publicados de 1984 a 2014. A maior parte dos modelos ao longo destes últimos 30 anos foi aplicada para análise do funcionamento dos ecossistemas, da pesca e, mais recentemente, para poluição, aquicultura e Áreas Marinhas Protegidas, principalmente em sistemas marinhos tropicais no Oceano Atlântico norte e central (COLLETER et al., 2015).

Numa escala global, inúmeros estudos de modelagem trófica vêm sendo desenvolvidos (VILLANUEVA et al., 2006; COLL et al., 2008; TSAGARAKIS et al., 2010; ANGELINI e VAZ-VELHO, 2011; XU et al., 2011; DÍAZ-URIBE et al., 2012; LEGAGNEUX et al., 2012; GUO et al., 2013; DE MUTSERT et al., 2015; FRETZER, 2015; DUTTA et al., 2016; EDDY et al., 2016; HAAK et al., 2017). O declínio da

biomassa pesqueira oceânica em todo o mundo foi analisado por Christensen et al. (2014), enquanto alguns modelos avaliaram a estrutura e o funcionamento dos ecossistemas (VILLANUEVA, 2015; TECCHIO et al., 2016) a partir da descrição e variação do fluxo trófico (NEIRA et al., 2014; SALCIDO-GUEVARA e ARREGUÍN-SÁNCHEZ, 2014; DE MUTSERT et al., 2015). Modelos tróficos também são utilizados para o desenvolvimento da aquicultura (KLUGER et al., 2015; IZQUIERDO-GOMEZ et al., 2016). A capacidade de suporte para a pesca também é objeto de muitos estudos com modelagem trófica (TOMCZAK et al., 2012; LONGO et al., 2015; GEERS et al., 2016). Finalmente, estes enfoques são úteis para a formulação de medidas de gestão, restauração e avaliação de impactos sobre os recursos e ecossistemas (PAULY et al., 2000; FORREST et al., 2015; ROSE et al., 2015; WOODWORTH-JEFCOATS et al., 2015; HALOUANI et al., 2016a).

No Brasil, o uso de modelos tróficos para descrição de ecossistemas aquáticos, apesar de ter apresentado um relativo aumento na última década, ainda é muito discreto e restrito principalmente a regiões lacustres, de rios e reservatórios (ANGELINI e PETRERE M., 1996; ANGELINI e AGOSTINHO, 2005; ANGELINI et al., 2010; GUBIANI et al., 2011; ROSA et al., 2014). O principal entrave para o desenvolvimento destes estudos é a carência de séries históricas e conhecimentos básicos sobre a ecologia e biologia dos ecossistemas e recursos vivos brasileiros (ANGELINI e GOMES, 2008). No entanto, apesar destas limitações, os ambientes marinhos e estuarinos também vêm sendo examinados, embora em menor proporção. Nascimento et al. (2011) avaliaram a estrutura trófica de comunidades demersais no sudeste do Brasil e em zonas de ressurgência (VASCONCELLOS e GASALLA, 2001; GASALLA e ROSSI-WONGTSCHOWSKI, 2004; VERA, 2010). Para o norte e nordeste do Brasil, os estudos em ambientes marinhos e estuarinos são ainda mais restritos. Freire et al. (2007, 2008) descreveram a região costeira do nordeste e avaliaram das políticas de pesca através de modelo trófico, Freire e Pauly (2010) avaliaram a diminuição do nível trófico das capturas no nordeste do Brasil, Wolff et al. (2000) geraram um modelo de fluxo trófico para o estuário do Rio Caeté no Pará e, mais recentemente, Xavier (2013) produziu um modelo com avaliação de ecossistema estuarino e recifal em Mamanguape (Paraíba). Não há nenhum modelo ecossistêmico de fluxo trófico publicado para a região costeira do estado de Pernambuco.

Com aproximadamente 187 km de extensão, o estado de Pernambuco engloba estuários com elevada biodiversidade, como na região norte do estado (Complexo

estuarino do Canal de Santa cruz e o estuário do Goiana; VASCONCELOS FILHO e OLIVEIRA, 1999; RAMOS et al., 2011; LACERDA et al., 2014) e na região sul (os estuários de Suape e Rio Formoso; PAIVA e ARAÚJO, 2010; PEREIRA et al., 2010; BEZERRA et al., 2011). Estes estuários também têm grande importância sócio-econômica dada à relevância da pesca como fonte de renda e proteína (CPRH, 2001; BARBOSA et al., 2007; PINTO et al., 2015). Na Barra de Sirinhaém, no litoral sul de Pernambuco, 60% da população apresenta ligação direta ou indireta com atividade pesqueira (LIRA et al., 2010), sendo responsável pela maior frota camaroeira artesanal de arrasto entre os municípios costeiros do estado de Pernambuco (TISCHER e SANTOS, 2003). Além disso, apresenta um estuário com uma fauna diversificada (SILVA-JÚNIOR et al., 2016), destacando, entre outras espécies, o Camurim (*Centropomus* spp.), Xaréu (*Caranx* spp.), Bagres (*Sciades* spp. e *Cathorops* spp.), Marisco (*Anomalocardia brasiliiana*), Tainhas (*Mugil* spp.), Carapebas e Carapicus (*Diapterus* spp. e *Eucinostomus* spp.).

A carência de informações do ponto de vista ecossistêmico das regiões estuarinas e marinhas do litoral de Pernambuco torna a elaboração de modelos matemáticos ecossistêmicos de extrema relevância do ponto de vista do manejo e ordenamento destes ambientes. A identificação das espécies-chaves, seu papel funcional no ecossistema, assim como a avaliação de cenários futuros, são apenas algumas das informações geradas por estes modelos, podendo contribuir para o uso sustentável destes biomas no Estado.

## **2. Objetivos**

### **2.1 Geral**

Avaliar a estrutura e dinâmica trófica do ambiente estuarino de Barra de Sirinhaém, litoral sul de Pernambuco.

### **2.2 Específicos**

- 1- Descrever o fluxo de energia na teia trófica estuarina de Barra de Sirinhaém;
- 2- Identificar as principais fontes de energia para a ictiofauna através do Ecopath;
- 3- Identificar as espécies-chave e avaliar seu efeito de controle na rede trófica;
- 4- Descrever a estrutura e as interações na rede trófica;
- 5- Avaliar os efeitos da pesca na rede trófica;

## 1. Referências Bibliográficas

ANGELINI, R.; AGOSTINHO, A. A. Food web model of the Upper Paraná River Floodplain: Description and aggregation effects. **Ecological Modelling**, v. 181, p. 109–121, 2005.

ANGELINI, R.; ALOÍSIO, G. R.; CARVALHO, A. R. Mixed food web control and stability in a Cerrado river (Brazil). **Pan-American Journal of Aquatic Sciences**, v. 5, p. 421–431, 2010.

ANGELINI, R.; GOMES, L. C. O artesão dos ecossistemas. Maringá: Eduem, 2008.

ANGELINI, R.; PETRERE M., J. **The ecosystem of Broa reservoir, Sao Paulo State, Brazil, as described using ECOPATHNaga**. Manila, 1996. .

ANGELINI, R.; VAZ-VELHO, F. Ecosystem structure and trophic analysis of Angolan fishery landings. **Scientia Marina**, v. 75, p. 309–319, 2011.

BARBOSA, M.; LIMA, H. C.; SILVA-JÚNIOR, E.; MOTA, A. D. S.; MENDOÇA, I. T. L.; SILVA-FILHO, E. J. Beneficiamento E Comercialização Do Pescado Na Região De Itapissuma, Pernambuco. **Revista Brasileira de Engenharia de Pesca**, v. 2, p. 44–55, 2007.

BEZERRA, J.; DIAZ, X. G.; NEUMANN-LEITÃO, S. Diversidade de larvas de peixes das áreas internas e externas do porto de Suape (Pernambuco-Brazil). **Tropical Oceanography Online**, v. 39, p. 1–13, 2011.

CHRISTENSEN, V.; COLL, M.; PIRODDI, C.; STEENBEEK, J.; BUSZOWSKI, J.; PAULY, D. A century of fish biomass decline in the ocean. **Marine Ecology Progress Series**, v. 512, p. 155–166, 2014.

CHRISTENSEN, V.; PAULY, D. E C O P A T H II - - a software for balancing steady-state ecosystem models and calculating network characteristics \*. **Science**, v. 61, p. 169–185, 1992.

COLL, M.; LIBRALATO, S.; TUDELA, S.; PALOMERA, I.; PRANOVI, F. Ecosystem overfishing in the ocean. **PLoS ONE**, v. 3, 2008.



LIRA, A. S. Aplicação de modelos tróficos em um estuário de Pernambuco: Um estudo de caso em Sir

COLLETER, M.; VALLS, A.; GUITTON, J.; GASCUEL, D.; PAULY, D.; CHRISTENSEN, V. Global overview of the applications of the Ecopath with Ecosim modeling approach using the EcoBase models repository. **Ecological Modelling**, v. 302, p. 42–53, 2015.

CPRH. Uso e Ocupação do Solo. In: **Diagnóstico socioambiental do litoral Sul de Pernambuco**. [s.l.] Companhia Pernambucana do Meio Ambiente, 2001. p. 41–49.

DE MUTSERT, K.; STEENBEEK, J.; LEWIS, K.; BUSZOWSKI, J.; COWAN, J. H.; CHRISTENSEN, V. Exploring effects of hypoxia on fish and fisheries in the northern Gulf of Mexico using a dynamic spatially explicit ecosystem model. **Ecological Modelling**, v. 331, p. 142–150, 2015.

DÍAZ-URIBE, J. G.; ARREGUÍN-SÁNCHEZ, F.; LERCARI-BERNIER, D.; CRUZ-ESCALONA, V. H.; ZETINA-REJÓN, M. J.; DEL-MONTE-LUNA, P.; MARTÍNEZ-AGUILAR, S. An integrated ecosystem trophic model for the North and Central Gulf of California: An alternative view for endemic species conservation. **Ecological Modelling**, v. 230, p. 73–91, 2012.

DICHMONT, C. M.; PASCOE, S.; JEBREEN, E.; PEARS, R.; BROOKS, K.; PEREZ, P. Choosing a fishery's governance structure using data poor methods. **Marine Policy**, v. 37, p. 123–131, 2013.

DUTTA, D.; SEKHAR, C.; ARNAB, D. A geo-spatial study on spatio-temporal growth of brackish water aquaculture along the coastal areas of West Bengal ( India ). **Modeling Earth Systems and Environment**, 2016.

EDDY, T. D.; LOTZE, H. K.; FULTON, E. A.; COLL, M.; AINSWORTH, C. H.; DE ARAÚJO, J. N.; BULMAN, C. M.; BUNDY, A.; CHRISTENSEN, V.; FIELD, J. C.; GRIBBLE, N. A.; HASAN, M.; MACKINSON, S.; TOWNSEND, H. Ecosystem effects of invertebrate fisheries. **Fish and Fisheries**, p. 40–53, 2016.

FORREST, R. E.; SAVINA, M.; FULTON, E. a.; PITCHER, T. J. Do marine ecosystem models give consistent policy evaluations? A comparison of Atlantis and Ecosim. **Fisheries Research**, v. 167, p. 293–312, 2015.

FREIRE, K. M. F.; CHRISTENSEN, V.; PAULY, D. Assessing fishing policies for

LIRA, A. S. Aplicação de modelos tróficos em um estuário de Pernambuco: Um estudo de caso em Sir

northeastern Brazil. **Pan-American Journal of Aquatic Sciences**, v. 2, p. 113–130, 2007.

FREIRE, K. M. F.; CHRISTENSEN, V.; PAULY, D.; FREIRE, K. M. F.; CHRISTENSEN, V.; PAULY, D. Description of the East Brazil Large Marine Ecosystem using a trophic model The columns of Table 2 in. **Scientia Marina**, v. 72, p. 477–491, 2008.

FREIRE, K. M. F.; PAULY, D. Fishing down Brazilian marine food webs, with emphasis on the east Brazil large marine ecosystem. **Fisheries Research**, v. 105, p. 57–62, 2010.

FRETZER, S. Using the Ecopath approach for environmental impact assessment-A case study analysis. **Ecological Modelling**, v. 331, p. 160–172, 2015.

FULTON, E. A. Approaches to end-to-end ecosystem models. **Journal of Marine Systems**, v. 81, p. 171–183, 2010.

FULTON, E. A.; LINK, J. S.; KAPLAN, I. C.; SAVINA-ROLLAND, M.; JOHNSON, P.; AINSWORTH, C.; HORNE, P.; GORTON, R.; GAMBLE, R. J.; SMITH, A. D. M.; SMITH, D. C. Lessons in modelling and management of marine ecosystems: the Atlantis experience. **Fish and Fisheries**, v. 12, p. 171–188, 2011.

GASALLA, M. A.; ROSSI-WONGTSCHOWSKI, C. L. D. B. Contribution of ecosystem analysis to investigating the effects of changes in fishing strategies in the South Brazil Bight coastal ecosystem. **Ecological Modelling**, v. 172, p. 283–306, 2004.

GEERS, T. M.; PIKITCH, E. K.; FRISK, M. G. An original model of the northern Gulf of Mexico using Ecopath with Ecosim and its implications for the effects of fishing on ecosystem structure and maturity. **Deep-Sea Research Part II: Topical Studies in Oceanography**, v. 129, p. 319–331, 2016.

GUBIANI, éder A.; ANGELINI, R.; VIEIRA, L. C. G.; GOMES, L. C.; AGOSTINHO, A. A. Trophic models in Neotropical reservoirs: Testing hypotheses on the relationship between aging and maturity. **Ecological Modelling**, v. 222, p. 3838–3848, 2011.

GUEDES, A. P. P.; ARAÚJO, F. G. Trophic resource partitioning among five flatfish species (Actinopterygii, Pleuronectiformes) in a tropical bay in south-eastern Brazil.

**Journal of Fish Biology**, v. 72, p. 1035–1054, 2008.

GUO, C.; YE, S.; LEK, S.; LIU, J.; ZHANG, T.; YUAN, J.; LI, Z. The need for improved fishery management in a shallow macrophytic lake in the Yangtze River basin: Evidence from the food web structure and ecosystem analysis. **Ecological Modelling**, v. 267, p. 138–147, 2013.

HAAK, D. M.; FATH, B. D.; FORBES, V. E.; MARTIN, D. R.; POPE, K. L. Coupling ecological and social network models to assess “transmission” and “contagion” of an aquatic invasive species. **Journal of environmental management**, v. 190, p. 243–251, 2017.

HALOUANI, G.; ABDOU, K.; HATTAB, T.; ROMDHANE, M. S.; BEN RAIS LASRAM, F.; LE LOC’H, F. A spatio-temporal ecosystem model to simulate fishing management plans: A case of study in the Gulf of Gabes (Tunisia). **Marine Policy**, v. 69, p. 62–72, 2016a.

HALOUANI, G.; BEN RAIS LASRAM, F.; SHIN, Y. J.; VELEZ, L.; VERLEY, P.; HATTAB, T.; OLIVEROS-RAMOS, R.; DIAZ, F.; M??NARD, F.; BAKLOUTI, M.; GUYENNON, A.; ROMDHANE, M. S.; LE LOC’H, F. Modelling food web structure using an end-to-end approach in the coastal ecosystem of the Gulf of Gabes (Tunisia). **Ecological Modelling**, v. 339, p. 45–57, 2016b.

IZQUIERDO-GOMEZ, D.; BAYLE-SEMPERE, J. T.; ARREGUÍN-SÁNCHEZ, F.; SÁNCHEZ-JEREZ, P. Modeling population dynamics and small-scale fisheries yields of fish farming escapes in Mediterranean coastal areas. **Ecological Modelling**, v. 331, p. 56–67, 2016.

KLUGER, L. C.; TAYLOR, M. H.; MENDO, J.; TAM, J.; WOLFF, M. Carrying capacity simulations as a tool for ecosystem-based management of a scallop aquaculture system. **Ecological Modelling**, v. 331, p. 44–55, 2015.

LACERDA, C. H. F.; BARLETTA, M.; DANTAS, D. V. Temporal patterns in the intertidal faunal community at the mouth of a tropical estuary. **Journal of Fish Biology**, v. 85, p. 1571–1602, 2014.

LEGAGNEUX, P.; GAUTHIER, G.; BERTEAUX, D.; BÊTY, J.; CADIEUX, M. C.;

LIRA, A. S. Aplicação de modelos tróficos em um estuário de Pernambuco: Um estudo de caso em Sir

BILODEAU, F.; BOLDUC, E.; MCKINNON, L.; TARROUX, a.; THERRIEN, J. F.; MORISSETTE, L.; KREBS, C. J. Disentangling trophic relationships in a High Arctic tundra ecosystem through food web modeling. **Ecology**, v. 93, p. 1707–1716, 2012.

LIRA, L.; MESQUITA, B.; SOUZA, M. M. C.; LEITE, C. A.; LEITE, ANA PAULA DE ALMEIDA FARIAS, A. M.; GALVÃO, C. Diagnóstico socioeconômico da pesca artesanal do litoral de pernambuco. Instituto ed. Recife: Instituto Oceanário de Pernambuco, 2010.

LONGO, C.; HORNBORG, S.; BARTOLINO, V.; TOMCZAK, M. T.; CIANNELLI, L.; LIBRALATO, S.; BELGRANO, A. Role of trophic models and indicators in current marine fisheries management. **Marine Ecology Progress Series**, v. 538, p. 257–272, 2015.

MODICA, L.; CARTES, J. E.; VELASCO, F.; BOZZANO, A. Juvenile hake predation on Myctophidae and Sternoptychidae: Quantifying an energy transfer between mesopelagic and neritic communities. **Journal of Sea Research**, v. 95, p. 217–225, 2015.

NASCIMENTO, M. C.; VELASCO, G.; OKEY, T. a.; CHRISTENSEN, V.; Z. AMARAL, a. C. Trophic model of the outer continental shelf and upper slope demersal community of the southeastern Brazilian Bight. **Scientia Marina**, v. 0, p. 763–779, 2011.

NEIRA, S.; MOLONEY, C.; CHRISTENSEN, V.; CURY, P.; SHANNON, L.; ARANCIBIA, H. Analysing changes in the southern Humboldt ecosystem for the period 1970–2004 by means of dynamic food web modelling. **Ecological Modelling**, v. 274, p. 41–49, 2014.

PAIVA, A. C. G.; ARAÚJO, M. E. Environmental characterization and spatial distribution of fish fauna in estuaries in the state of Pernambuco, Brazil. **Tropical Oceanography Online**, v. 38, p. 1–46, 2010.

PAULY, D.; CHRISTENSEN, V.; WALTERS, C. Ecosim, Ecospace, and Ecopath as tools for evaluating ecosystem impact of fisheries. **ICES Journal of Marine Science**, v. 57, p. 697–706, 2000.

PEREIRA, P. H. C.; FERREIRA, B. P.; REZENDE, S. M. Community structure of the ichthyofauna associated with seagrass beds (*Halodule wrightii*) in Formoso River estuary

LIRA, A. S. Aplicação de modelos tróficos em um estuário de Pernambuco: Um estudo de caso em Sir

- Pernambuco, Brazil. **Anais da Academia Brasileira de Ciências**, v. 82, p. 617–628, 2010.

PINTO, M. F.; MOURÃO, J. S.; ALVES, R. R. N. Use of ichthyofauna by artisanal fishermen at two protected areas along the coast of Northeast Brazil. **Journal of Ethnobiology and Ethnomedicine**, v. 11, p. 1–33, 2015.

POLOVINA, J. J. Model of a coral reef ecosystem - I. The ECOPATH model and its application to French Frigate Shoals. **Coral Reefs**, v. 3, p. 1–11, 1984.

RAMOS, J. A. A.; BARLETTA, M.; DANTAS, D. V.; LIMA, A. R. A.; COSTA, M. F. Influence of moon phase on fish assemblages in estuarine mangrove tidal creeks. **Journal of Fish Biology**, v. 78, p. 344–354, 2011.

ROMAGNONI, G.; MACKINSON, S.; HONG, J.; MARIA, A. The Ecospace model applied to the North Sea : Evaluating spatial predictions with fish biomass and fishing effort data. **Ecological Modelling**, v. 300, p. 50–60, 2015.

ROSA, R.; CARVALHO, A. R.; ANGELINI, R. Integrating fishermen knowledge and scientific analysis to assess changes in fish diversity and food web structure. **Ocean and Coastal Management**, v. 102, p. 258–268, 2014.

ROSE, K. a; SABLE, S.; DEANGELIS, D. L.; YUREK, S.; TREXLER, J. C.; GRAF, W.; REED, D. J. Proposed best modeling practices for assessing the effects of ecosystem restoration on fish. **Ecological Modelling**, v. 300, p. 12–29, 2015.

SALCIDO-GUEVARA, L. A.; ARREGUÍN-SÁNCHEZ, F. Effects of biomass changes in the supply–demand balance of energy in aquatic food webs. **Ecological Modelling**, v. 276, p. 64–79, 2014.

SILVA-JÚNIOR, C. A. B.; MÉRIGOT, B.; LUCENA-FRÉDOU, F.; FERREIRA, B. P.; COXEY, M. S.; REZENDE, S. M.; FRÉDOU, T. Functional diversity of fish in tropical estuaries: A traits-based approach of communities in Pernambuco, Brazil. **Estuarine, Coastal and Shelf Science**, 2016.

SIMPFENDORFER, C. A.; HEUPEL, M. R.; WHITE, W. T.; DULVY, N. K. The importance of research and public opinion to conservation management of sharks and

LIRA, A. S. Aplicação de modelos tróficos em um estuário de Pernambuco: Um estudo de caso em Sir

rays: A synthesis. **Marine and Freshwater Research**, v. 62, p. 518–527, 2011.

SVANBÄCK, R.; BOLNICK, D. I. Intraspecific competition drives increased resource use diversity within a natural population. **Proceedings of the Royal Society B: Biological Sciences**, v. 274, p. 839–844, 2007.

TECCHIO, S.; CHAALALI, A.; RAOUX, A.; TOUS RIUS, A.; LEQUESNE, J.; GIRARDIN, V.; LASSALLE, G.; CACHERA, M.; RIOU, P.; LOBRY, J.; DAUVIN, J. C.; NIQUIL, N. Evaluating ecosystem-level anthropogenic impacts in a stressed transitional environment: The case of the Seine estuary. **Ecological Indicators**, v. 61, p. 833–845, 2016.

TISCHER, M.; SANTOS, M. C. F. Composição E Diversidade Da Ictiofauna Acompanhante De Peneídeos No Litoral Sul. **Arquivos de Ciência do Mar**, v. 36, p. 105–118, 2003.

TOMCZAK, M. T.; NIIRANEN, S.; HJERNE, O.; BLENCKNER, T. Ecosystem flow dynamics in the Baltic Proper-Using a multi-trophic dataset as a basis for food-web modelling. **Ecological Modelling**, v. 230, p. 123–147, 2012.

TRAVERS, M.; SHIN, Y. J.; JENNINGS, S.; CURY, P. Towards end-to-end models for investigating the effects of climate and fishing in marine ecosystems. **Progress in Oceanography**, v. 75, p. 751–770, 2007.

TSAGARAKIS, K.; COLL, M.; GIANNOULAKI, M.; SOMARAKIS, S.; PAPACONSTANTINOU, C.; MACHIAS, a. Food-web traits of the North Aegean Sea ecosystem (Eastern Mediterranean) and comparison with other Mediterranean ecosystems. **Estuarine, Coastal and Shelf Science**, v. 88, p. 233–248, 2010.

ULANOWICZ, R. E. Growth and development: ecosystems phenomenology. [s.l.] Lincoln, NE: toExcel Press, 1986.

VASCONCELLOS, M.; GASALLA, M. A. Fisheries catches and the carrying capacity of marine ecosystems in southern Brazil. **Fisheries Research**, v. 50, p. 279–295, 2001.

VASCONCELOS FILHO, A. de L.; OLIVEIRA, A. M. E. Composição e ecologia da ictiofauna do Canal de Santa Cruz (Itamaracá - PE, Brasil). **Trabalho oceanográfico**

LIRA, A. S. Aplicação de modelos tróficos em um estuário de Pernambuco: Um estudo de caso em Sir

**UFPE**, v. 27, p. 101–113, 1999.

VERA, G. R. Modelagem trófica do ecossistema de ressurgência de cabo frio, rio de janeiro. 2010. Universidade de São Paulo, São Paulo, 2010.

VILLANUEVA, M. C. Contrasting tropical estuarine ecosystem functioning and stability: A comparative study. **Estuarine, Coastal and Shelf Science**, v. 155, p. 89–103, 2015.

VILLANUEVA, M. C.; OUEDRAOGO, M.; MOREAU, J. Trophic relationships in the recently impounded Bagré reservoir in Burkina Faso. **Ecological Modelling**, v. 191, p. 243–259, 2006.

WALTERS, C. J.; PAULY, D.; CHRISTENSEN, C. V. Structuring dynamic models of exploited ecosystems from trophic mass-balance assessments. **Reviews in Fish Biology and Fisheries**, v. 7, p. 139–172, 1997.

WALTERS, C.; PAULY, D.; CHRISTENSEN, V. ECOSPACE: prediction of mesoscale spatial patterns in trophic relationships of exploited ecosystems, with particular reference to impacts of marine protected areas. v. 2, p. 539–554, 1999.

WETHERBEE, B. M.; CORTÉS, E. Food consumption and feeding habits. In: CARRIER, J. C.; MUSICK, J. A.; HEITHAUS, M. R. (Ed.). **Biology of sharks and their relatives**. Boca Raton: CRC Press LLC, 2004. p. 225–246.

WOLFF, M.; KOCH, V.; ISAAC, V. A Trophic Flow Model of the Caeté Mangrove Estuary (North Brazil) with Considerations for the Sustainable Use of its Resources. **Estuarine, Coastal and Shelf Science**, v. 50, p. 789–803, 2000.

WOODWORTH-JEFCOATS, P.; POLOVINA, J.; HOWELL, E.; BLANCHARD, J. Two takes on the ecosystem impacts of climate change and fishing: comparing a size-based and a species-based ecosystem model in the central North Pacific. **Progress in Oceanography**, 2015.

XAVIER, H. J. D. A. Teia trófica e fluxo de energia no estuário do rio mamanguape, paraíba, brasil. 2013. Universidade Federal da Paraíba, 2013.

XU, S.; CHEN, Z.; LI, S.; HE, P. Modeling Trophic Structure and Energy Flows in a

LIRA, A. S. Aplicação de modelos tróficos em um estuário de Pernambuco: Um estudo de caso em Sir

Coastal Artificial Ecosystem Using Mass-Balance Ecopath Model. **Estuaries and Coasts**, v. 34, p. 351–363, 2011.

YOUNG, J. W.; OLSON, R. J.; MÉNARD, F.; KUHNERT, P. M.; DUFFY, L. M.; ALLAIN, V.; LOGAN, J. M.; LORRAIN, A.; SOMES, C. J.; GRAHAM, B.; GOÑI, N.; PETHYBRIDGE, H.; SIMIER, M.; POTIER, M.; ROMANOV, E.; PAGENDAM, D.; HANNIDES, C.; CHOY, C. A. Setting the stage for a global-scale trophic analysis of marine top predators: a multi-workshop review. **Reviews in Fish Biology and Fisheries**, v. 25, p. 261–272, 2015.



## 2. Artigo científico

Artigo científico a ser encaminhado a Revista  
[Estuarine and Coastal Shelf Science].

#### **4.1 Trophic structure in a neotropical estuary: the case study of Sirinhaém, Northeastern Brazil**

Alex Lira <sup>a</sup>

<sup>a</sup> Universidade Federal Rural de Pernambuco (UFRPE), Departamento de Pesca e Aquicultura, Av. Dom Manuel s/n, Recife, Pernambuco 52171-900, Brazil

##### **Introduction**

Rivers, estuaries and coastal zones, intrinsically linked through transfers of water, nutrients and biota (O'BRIEN et al., 2016) are considered essential habitats for feeding, reproduction and growth of many aquatic organisms (ODUM and BARRET, 2007; CLOERN et al., 2014). Estuaries have a relatively low biodiversity (TECCHIO et al., 2016) and are considered as valuable areas of the world (COSTANZA et al., 2014) given that they provide many ecosystem services (BARBIER et al., 2011; BOEREMA and MEIRE, 2016). However, intensive anthropogenic activity, mainly the area on the river basin and nearby the estuaries, often affect water quality and aquatic biodiversity (VIANA et al., 2012) and consequently, changes the internal functioning of ecosystems (HOOPER et al., 2005).

The limitations of single-species approaches front the new global challenges arising from climate changes and ecosystem degradation (KALTENBERG and BENOIT-BIRD, 2016). In this context, ecosystem models, which take into account the interactions between the different components of the ecosystem, have been increasingly developed and applied worldwide to support the Ecosystem Approach to Fisheries (EAF) (GARCIA et al., 2003; CORRALES et al., 2015). Those models are a reality as a tool for ecosystem management, due to the capacity to include a wide range of processes across a wide range of scales, associated with quantitative and easy-to-interpret results (ROMAGNONI et al., 2015).

Amongst the family of models which takes into account the Ecosystem Approach to Fisheries (EAF), trophic models (PIKITCH et al., 2004) have arisen as promising to the decision makers in terms of management advice. Trophic models allow the evaluation of the energetic flux between the species, also describing the functional role of species and maturity of the ecosystems (CHRISTENSEN and PAULY, 1993). This family of models may also simulate scenarios like overfishing (CÁCERES et al., 2016; WANG et al., 2016), and also has been used to evaluate the mechanisms which regulate the growth

and development of aquatic food webs (e.g. resource limitation, bottom-up and top-down control in food web) (ANGELINI et al., 2010; RUIZ et al., 2016). These models synthesize the comprehension of the systems, providing knowledge about the connectivity between the components, defining problems and making forecasts.

The Ecopath with Ecosim (EwE) is an ecosystem model based on the principle of energy balance and trophic flows in aquatic ecosystems. It is based on the information of biomass, diet, production and consumption rates of the main species of the ecosystems (PLAGÁNYI, 2007; HEYMANS et al., 2016). EwE is has been applied since 1984 and more than 433 studies have been published mainly focusing on tropical marine systems aiming at describing the trophic structure and fisheries-related issues (COLLETER et al., 2015). Although the number of EwE models has increased in the last two decades in Brazil, it is mainly restricted to lakes, reservoirs, rivers (GUBIANI et al., 2011; ANGELINI et al., 2013; ROSA et al., 2014) and marine systems (FREIRE et al., 2008; NASCIMENTO et al., 2011) in the south portion of the country. However, for estuarine ecosystems, only two studies are reported in Brazil, one of them (grey literature) in the northeastern part of the country (Wolff et al., 2000; Xavier 2013).

In Northeastern Brazil there are many estuaries (PAIVA and ARAÚJO, 2010), however, urbanization, mangrove degradation and overfishing have hampered these environments (Lessa et al., 2009). Elfes et al. (2014) applied the Ocean Health Index framework (HALPERN et al., 2012) to the Brazilian coastal ecosystems, and found lowest scores in this Brazilian region, given the high impact by sugar cane and others agribusiness industries (MELLO, 2009) which degrade rivers and consequently estuarine areas, impairing fisheries activities which are fundamental for local population (TISCHER and SANTOS, 2003).

This study aims to develop a trophic model, using the Ecopath approach in the Sirinhaém estuary, located within Protected Areas (APA): APA of Guadalupe and APA of Sirinhaém, both with no management plan. The main objectives of this study are: i) to describe the food web structure and trophic interactions; ii) to identify key species and evaluate the top-down or bottom-up effect; and iii) to evaluate the fishing effects on food web. Results can provide critical insights to evaluate the effective decision-making and policy actions to multispecies management and ecosystem conservation.

## Materials and methods

### *Study area*

The Sirinhaém River Estuary (SRE) is located in the southern coast of Pernambuco State (Northeast Brazil), 08°35'S and 035°02' W. It is characterized by a high density of mangrove (MAIA et al., 2006) and is located between the Marine Protected Area of Guadalupe and the Marine Protected Area of Sirinhaém (Fig. 1). The SRE, classified as a coastal plain estuary, have 9.5 km long, 350 m wide (increasing up to 800 m in the river mouth) with depths varying between 1.2 and 4.5 m (SILVA et al., 2011). The local climate is tropical, with rainfall of 20 – 450 mm. yr<sup>-1</sup> (rainy season is between May and October, APAC, 2015), mean temperature of 29°C, pH range is between 5.8 and 8.5 and salinity between 0 and 36 (SILVA, 2009).

### *Ecopath with Ecosim model*

The Ecopath model used in this study is based on 2 master equations: (1) used for definition of production and (2) for definition of consumption (CHRISTENSEN et al., 2008).

$$P_i = (B_i \times M2_i) + (P_i \times (1 - EE_i)) + E_i + BA_i + Y_i \quad (1)$$

$$Q_i = P_i + R_i + U_i \quad (2)$$

Where  $P_i$  is the total production for each group  $i$ ;  $B_i$  the biomass of each group  $i$ ;  $M2_i$  is the instantaneous predation rate for group  $i$ ;  $EE_i$  is the ecotrophic efficiency (the fraction of production consumed, fished or exported out of the system) for each group  $i$ ;  $E_i$  is the net migration rate (emigration–immigration);  $BA_i$  is the biomass accumulation rate for each group  $i$ ;  $Y_i$  the total fishery catch rate of  $i$ ;  $Q_i$ ,  $P_i$ ,  $R_i$  and  $U_i$  is respectively consumption, production, respiration and unassimilated food for each group  $i$ .

The overall equation (3) of the Ecopath model considers the biomass, production and consumption rate and the diet of the each group analyzed in the model (CHRISTENSEN and WALTERS, 2004):

$$B_i \times \left(\frac{P}{B}\right)_i = \sum_{j=1}^n B_j \times \left(\frac{Q}{B}\right)_j \times DC_{ji} + Y_i + E_i + BA_i + B_i \times \left(\frac{P}{B}\right)_i \times (1 - EE_i) \quad (3)$$

$P/B_i$  is the production rate of  $i$ ,  $Q/B_j$  is the consumption rate of predator  $j$ ,  $B_j$  is the biomass of the predating group  $j$  and  $DC_{ji}$  is the fraction of prey  $i$  in the average diet of predator  $j$ .

In the absence of information,  $BA_i$  and  $E_i$  were assumed as equal the 0 (COLL et al., 2006a).

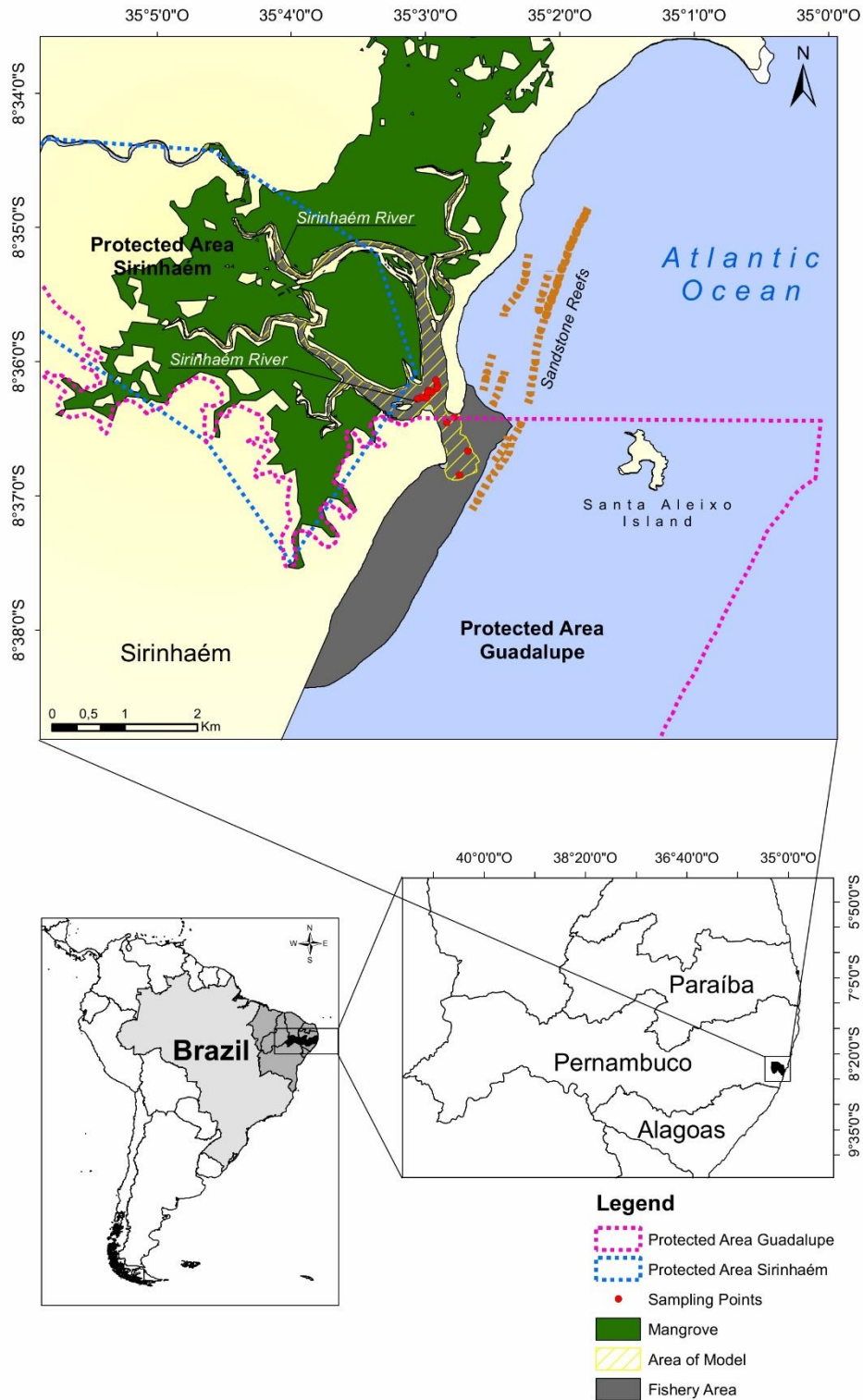

Figure 1 Estuary of Sirinhaém River, Northeastern Brazil, and the area of model with location of the sampling points carried out between 2013 and 2014

The Ecosim is a model of time-dynamic simulation that allows the evaluation of changes in food web to ecosystem level, based into initial conditions and parameter definition from the Ecopath model (CHRISTENSEN and WALTERS, 2004). The model uses a system of ordinary differential equations that derive from Eq.(3) (WALTERS et al., 1997, 2000).

$$dB_i/dt = g_i \times \sum_j Q_{ji} - \sum_j Q_{ij} + I_i - (M_i + F_i + e_i) \times B_i \quad (4)$$

Where  $dB_i/dt$  is the change in B of group  $i$  over time  $t$ ,  $g_i$  is the net growth efficiency,  $Q_{ji}$  is the consumption rate of group  $i$  on group  $j$ , and  $Q_{ij}$  is the consumption rate of group  $j$  on group  $i$ .  $I_i$  is the immigration rate,  $M_i$  is the non-predation natural mortality rate,  $F_i$  is the fishing mortality rate, and  $e_i$  is the emigration rate. The consumption rates between prey  $i$  consumed by predator  $j$  are calculated based on the “foraging arena” theory, in which the prey biomass ( $B_i$ ) available to a predator is divided into vulnerable and non-vulnerable components, where the transfer rate between these two components is the vulnerability rate ( $v_{ij}$ ), which determines the type of foodweb control (top-down, bottom-up or mixed). We used the Ecopath and Ecosim software (version 6.5.) in this study.

### *Model Components*

#### Fish

For the model, fishes were captured quarterly, between March of 2013 and May of 2014 with a 250 m long, beach seine 2.5 m high and mesh size of 25 mm. Three sets were carried out for each sample. The swept area was calculated by tracking of trawl with GPS using the software *Image J*. Fish were stored in cool boxes with ice and then frozen for future analysis. The fish biomass was estimated through the sum of the individual weights of each group divided by the total dragged area (0.0787 Km<sup>2</sup>), expressed in  $t.km^2$ . In order to minimize problems related to underestimation of fish assemblages due to gear selectivity, a catchability model (LAURETTA et al., 2013) was applied for the fish compartments (eq. 5 and 6).

$$p = qL \times E \times A^{-1} \quad (5)$$

$$N = C \times p^{-1} \quad (6)$$

Where  $p$  is mean proportion of the population captured,  $qL$  is catchability coefficient,  $E$  is effort (total area dragged),  $A$  is habitat area (1.71 km<sup>2</sup>),  $N$  is population abundance and  $C$  is the catch. The catchability coefficient ( $qL$ ) was adapted for our fish community

considering the same genus, body and/or fin format (see supplementary material - SOM 1).

The production (P/B) was obtained with two methods: when possible, we used linearized length converted catch curve to estimate the total mortality Z (CHAPMAN and ROBSON, 1960; PAULY, 1983) as P/B (ALLEN, 1971). For species where there is no fishery mortality (F) data, we used the natural mortality (PAULY, 1980) as P/B (eq. 7).

$$PB = M = k^{0.65} \times L_{\infty}^{-0.279} \times T^{0.463} \quad (7)$$

Where M is natural mortality (year<sup>-1</sup>), k is the growth coefficient (year<sup>-1</sup>), L<sub>∞</sub> is the asymptotic length (cm) and T is the mean water temperature (°C). The parameters k and L<sub>∞</sub> were obtained from the literature or using the empirical equations of Le Quesne and Jennings (2012) and Froese and Binohlan (2000) respectively. T was obtained *in situ* and considered as the mean annual temperature, 27.8°C (See SOM 2).

The consumption (Q/B) (eq. 8) per biomass was obtained according to the following equation (PALOMARES and PAULY, 1998).

$$\text{Log QB} = 7.964 - 0.204 \times \log W_{\infty} - 1.965 \times T' + 0.083 \times \text{Ar} + 0.532 \times \text{H} + 0.398 \times \text{D} \quad (8)$$

Where W<sub>∞</sub> is asymptotic weight (g), L<sub>max</sub> is maximum length of the species, T' is temperature in Kelvin, and Ar is aspect ratio of the caudal fin. W<sub>∞</sub> was estimated using the equation W<sub>∞</sub>=a · L<sub>∞</sub><sup>b</sup>, where a and b were based on Viana et al. (2016) and L<sub>∞</sub> was obtained as described above. L<sub>max</sub> was obtained from the literature. Photographic records of the caudal fin were taken for each species with *image J* software. Ar was hence calculated as Ar = h<sup>2</sup>/s, where (h) is height of caudal fin and (s) is the surface area of the fin, extending to the narrowest part of the caudal peduncle (PALOMARES and PAULY, 1998), and obtained with software *image J*, through the photography of caudal fins. H and D represent the feeding type (h: 1 and d: 0 for herbivores; h: 0 and d: 1 for detritivores; h: 0 and d: 0 for carnivores). See SOM 4 for the parameters used to calculate the consumption (Q/B).

#### *Diet composition*

Diet information for the fish species of each compartment was primarily estimated from complementary studies of trophic guilds, obtained from stomach contents analyses of the study area (see SOM 6 for sources). When not available and for the other groups

of the model, information were based on the literature. Table 3 shows the diet matrix used in the model.

#### *Other compartments*

For macrobenthos, we collected the sediment manually in three points of the estuary: channel, margin and river mouth. The biomass (Fiddler crabs, Polychaetes, Bivalves, Gastropods) was estimated using the relationship between the sample volume and the depth of the sediment where most of the benthic organisms are mainly distributed (following Xavier, 2013). In the present study, the depth of 10 cm is considered as the most probable area of distribution of the benthic fauna were the majority part of the interactions between the epifauna and the water (ROSENBERG, 2001). P/B of macrobenthos (Fiddler crabs, Polychaetes, Gastropods) was estimated based on the equation of Brey (1999), considering the maximum age for each group obtained from the literature and maximum body mass based on our data base. The Q/B was based on the equation proposed by Nichols (1974). All data of P/B and Q/B used in the model were obtained from literature. See SOM 5 for parameters, equations and references used.

The Phytoplankton and epiphyton biomass were obtained from the literature (Baltar et al., 1996; Silva, 2009), based on studies developed nearby the area. Zooplankton, microphytobenthos and the other groups of the macrobenthos (*Litopenaeus* spp and *Callinectes* spp.) were not sampled; therefore, the biomass was estimated from the model. The Detritus of the ecosystem was given following the equation proposed by Pauly et al. (1993).

For Phytoplankton, Epiphyton and Microphytobenthos, P/B and EE were obtained from the literature and the model, respectively. The P/B, Q/B and EE values of Zooplankton, Bivalves, Blue crabs and Shrimp were obtained from the literature.

#### *Fishery landings*

For this model, we considered the landings of the main fishery resources caught by the artisanal fleet landed in Sirinhaem (coast and estuary), from the years of 2000 and 2007 (IBAMA/CEPENE 2007). Although there is fishery statistics available for a longer time series, there are different methodologies of data collection. Landings from this period was standardized in terms of methods and data was considered as more accurate. Since the official landings are not divided by area (e.g. estuary and coast), we assumed different percentages of the total landing for the estuarine area, for each compartment explored by the fishery activity. We obtained this information based on literature and, logbooks and database available in the Laboratory (see SOM 6). The input landings data



in the model was obtained by dividing the average annual catch of the estuarine area (t) by the fishing area ( $5.26 \text{ km}^2$ ).

#### *Balancing of model and Network analysis*

The Pedigree index was calculated to quantify the uncertainty related to each input value (B, PB, QB and diet matrix) in the model (CHRISTENSEN et al., 2005), ranging from 0 (low precision information) to 1 (data and parameters fully rooted in local data). For the evaluation of the equilibrium of the model, following Christensen and Walters (2004) and Christensen et al. (2008), when inconsistencies were detected, the initial input parameters were adjusted by a step-by-step approach for each group. Ecotrophic efficiency (EE) (which should be  $\leq 1$ ) is the first step taken into account for model diagnostic. The production to consumption ratio (P/Q) is supposed to be between 0.05 (lower P/Q values) and 0.3 (have higher P/Q values), with exception of the top predators (GUENETTE, 2014). For all groups, the respiration/assimilation (R/A) must be  $< 1$  (DARWALL et al., 2010). In order to balance the groups, which presented  $EE > 1$ , we reallocated the consumption to other preys that were part of the diet of the predators, as already applied by Albouy et al. (2010).

The transfer efficiency (TE) is the ratio between the sum of exports and flows predated by the next level and the throughput on the trophic level. Trophic interactions, estimated flows of detritus and the TE to upper trophic levels were described by diagram flow and “Lindeman spine” graphic (LINDEMAN, 1942), that synthetize all groups into a simple linear food web. The mixed trophic impact routine-MTI (ULANOWICZ and PUCCIA, 1990) and keystone index (KS3) developed by Valls et al. (2015) were used, respectively, to analyze the response of both direct and indirect impacts of one group on another, and to identify keystone and dominant groups (groups that play an important role in the food web with relatively low biomass and a large relative impact, respectively). The top-down effect (td), as percentage contributions to the keystone index for each species, was evaluated through the proportion of the negative values that contributed to the sum of overall effect of group  $i$  on all the other groups in the food web (LIBRALATO et al., 2006).

Also, in order to describe the ecological status (ODUM, 1969) and functioning of the Sirinhaém estuary, we obtained the Total System Throughput (TST), which is the sum of all flows of the system (consumption, exports, respiration, and flows to detritus). The

total primary production/total respiration (TPP/TR) and the System Omnivory Index (SOI) were also obtained. TPP/TR describes the maturity of the ecosystem (ODUM, 1971) and values close to 1 are related to more mature systems. SOI is based on the variance of the TL of prey consumed by predators, ranging between 0 (full specialist consumers) and 1 (dominance of groups with high food plasticity, CHRISTENSEN et al., 2008). Connectance index (CI), that is a relation of the observed number of food links in the system relative to the number of possible links (GARDNER and ASHBY, 1970), was also obtained. Higher mature systems tends to have a greater connectivity than the less mature (CHRISTENSEN and WALTERS, 2004; CHRISTENSEN et al., 2005). Ascendency (A) and overhead (O) (ULANOWICZ, 1986), which correspond to a measure of system maturity and a measure of ecosystem stability, respectively (CHRISTENSEN, 1995), was estimated. Finn's cycling index (FCI) represent the proportion of recycled flows in the system (FINN, 1976), and can be used as a measure of ecosystem resilience (VASCONCELLOS et al., 1997). For more detailed description of these ecological indices, see Heymans et al. (2014).

#### *Landing Analysis*

One of the criteria that can be used to compare the ecological footprint of fishing activities is the Primary Production Required (PPR) to sustain fisheries (COLL et al., 2006b). This metric was mainly used to quantify the pressure of fishing on the ecosystems by calculating the PPR to sustain catches (PAULY and CHRISTENSEN, 1995; FABIO et al., 2016). Another EwE output expressed as function of the PPR is the Loss in secondary production index (*L* index) (Libralato et al., 2008), defined as (9):

$$L = - \frac{PPR_i \times TE^{TL_i - 1}}{P_1 \times \ln(TE)} \quad (9)$$

Where  $P_1$  = indicates the autotrophic production and detritus production by the food web from Calculated Net Primary Production (PP) + Flows to Detritus (FLDET), TE is the average efficiency of transfer between the TLs,  $PPR_i$  and  $TL_i$  are the Primary Production Required and TL for/of component *i* respectively. This method also allows the estimate of the probability of sustainability of the fishing ( $psust$ ) (LIBRALATO et al., 2008). The reference values of the Lindex ( $L \pm sd$ ) for sustainable fishery, with confidence level of 75% and 95%, is  $L_{75\%} = 0.021 \pm 0.013$  and  $L_{95\%} = 0.007 \pm 0.007$  (COLL et al., 2008).

The indices that reflect the biodiversity are also important parameters for evaluating the effect of fisheries in the ecosystem. Kempton index (Q) expresses biomass species diversity of functional groups with  $TL \geq 3$  (KEMPTON and TAYLOR, 1976), considered as an indicator of biodiversity evenness (AINSWORTH and PITCHER, 2006). Kempton index (Q) usually increases with the increasing biomass of high trophic level species and decreases with increase of the impacts under these species (e.g. fishing) (GOLDSWORTHY et al., 2013). Lower values of Q imply in a low evenness and richness and higher group dominance (ANGELINI et al., 2013).

To assess if the ecosystem can support fishing pressure, we created a set of fishing simulations for the SRE to assess the ecosystem changes induced by fishing and to verify the alterations of the Kempton and L indexes. It was performed 12 simulations, which represented 20-year of scenarios, increasing and decreasing fishing mortality for all species targeted by the fishery. The simulations were performed maintaining the initial Ecopath fishing mortality ( $F_0$ ) for the first 3 years of the simulation, then increasing or decreasing the fishing mortality in year 4 from  $F_0$  to  $F = F_0 \times f$  (where  $f$  is a multiplier factor), maintaining the last value of  $F$  for the last 16 years of the simulation (Fig. 2). Thus, the simulations explored the effects of fishing mortality ( $F$ ) ranging from 0 (no fishing) to 0.95 (SOM 7).

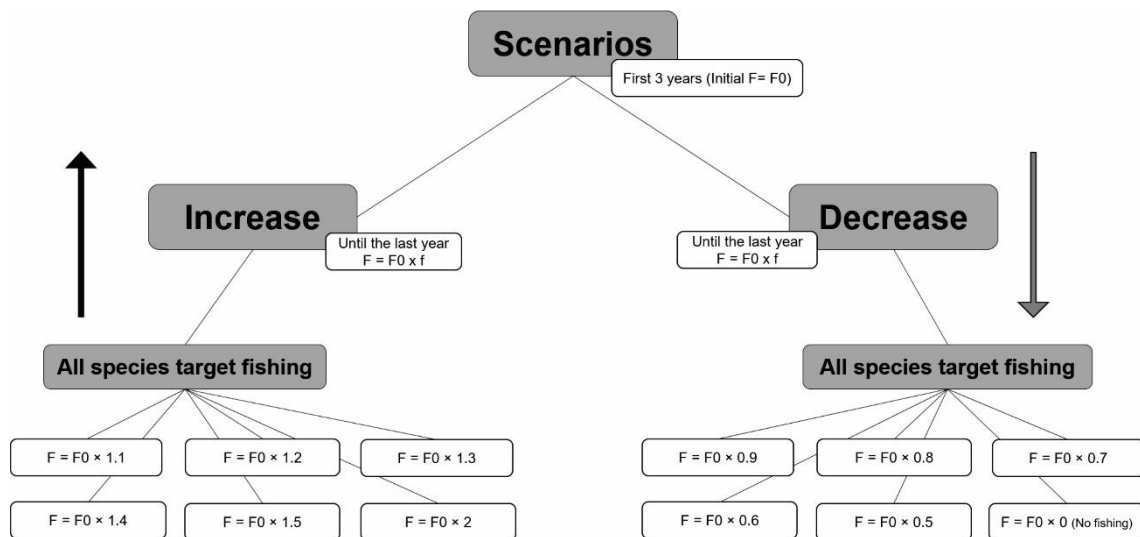

Figure 2. Scheme of the 12 simulations, which represent 20-year of scenarios with increasing and decreasing fishing mortality for all fishing target species in the Estuary of Sirinhaém River, Northeastern Brazil.

We used the Ecosim routine to simulate the scenarios. Usually the Ecosim vulnerability parameters are determined through the best fit considering the observed time series (e.g. Halouani et al., 2016; Wang et al., 2012). However, no time-series data were available in the present study to perform an authentic calibration; thus, we used the Ecosim default vulnerability parameters (Christensen and Walters, 2004;  $v = 2$ , which indicate a mixed food web control), and only the fishing mortality was changed given the different simulations, as proposed by Angelini et al. (2013). Therefore, the evaluation fishing pressure on food web was obtained from temporal changes in outputs of the Kempton Q indexes, L index, psust, mean trophic level of the catch (mTLc) and biomass of the groups Fish and Invertebrates for the 20-years simulations.

## Results

### Basic estimation

Sirinhaém model included 26 trophic groups: three primary producers, zooplankton, six groups of macrobenthos, 15 groups of fishes and one detritus (Table 1). Fish groups were selected given the importance in abundance (% in weight of the samplings) (Fig. 3), landings relevance, position in water (surface or bottom) and trophic guilds (ELLIOTT et al., 2007; MOURÃO et al., 2014). Some fish components represent more than one species (Table.1).

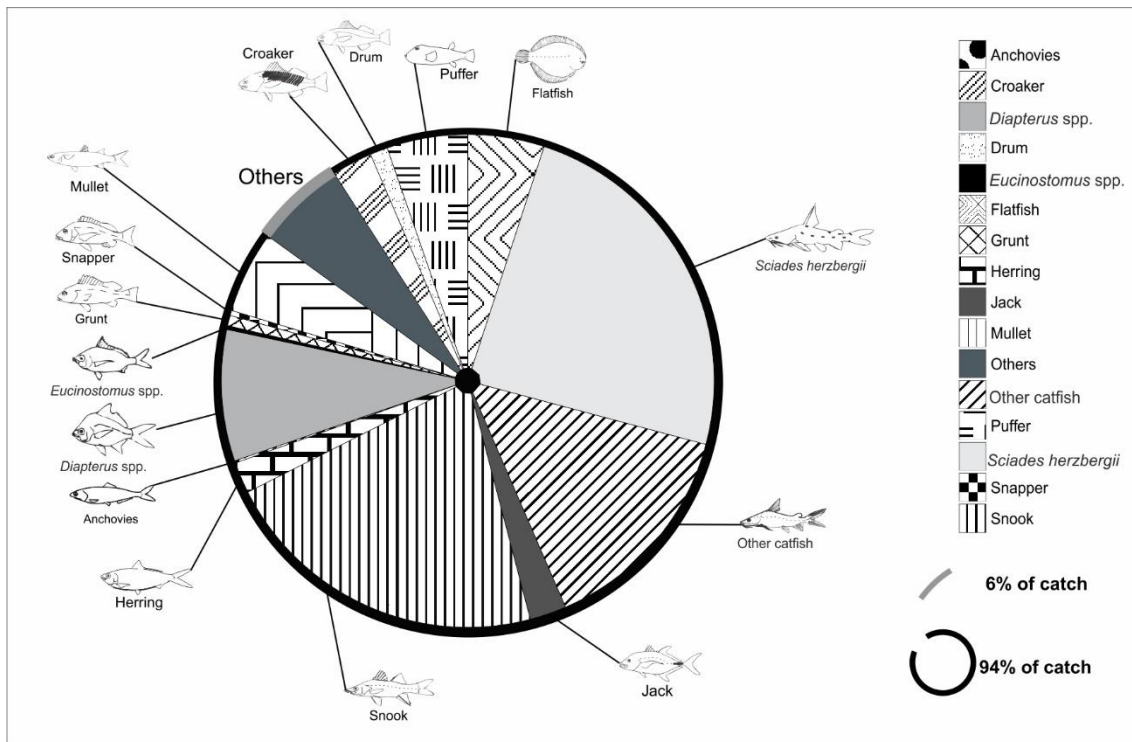

Figure 3 Fish composition, expressed in % in weight; captured with manual beach seine in the Estuary of Sirinhaém River, Northeastern Brazil.

Table 1 Taxonomic composition and trophic guilds of each compartment of the model in the Estuary of Sirinhaém River, Northeastern Brazil

Group name	Family	Scientific name	Guilds
1 Phytoplankton	-	-	Productor
2 Zooplakton	-	-	Primary consumer
3 Epiphyton	-	-	Productor
4 Microphytobenthos	-	-	Productor
5 Fiddler crabs	Ocypodidae	<i>Uca</i> spp.	Deposit-feeders
6 Polychaetes	-	-	Deposit-feeders
7 Bivalves	Veneridae	<i>Anomalocardia brasilliana</i>	Filter-feeding
8 Gastropods	Neritidae	<i>Neritina virginia</i>	Scrapers
9 Blue crab	Portunidae	<i>Callinectes</i> spp.	Zoobenthivorous
10 Shrimp	Peneidae	<i>Farfantepenaeus</i> spp.	Detritivore
11 Herring	Clupeidae	<i>Opisthonema oglinum</i>	Zooplanktivore
12 Anchovies	Engraulidae	<i>Cetengraulis edentulus</i> <i>Anchoa spinifer</i>	Zooplanktivore
13 Mullet	Mugilidae	<i>Mugil</i> spp	Omnivore/Detritivore
14 Flatfish	Achiridae	<i>Achirus lineatus</i> <i>Trinectes paulistanus</i>	Zoobenthivore
15 Puffer	Tetraodontidae	<i>Sphoeroides testudineus</i>	Opportunist/Omnivore
16 <i>Eucinostomus</i> spp	Gerreidae	<i>Eucinostomus argenteus</i> <i>Eucinostomus gula</i>	Zoobenthivore
17 <i>Diapterus</i> spp	Gerreidae	<i>Diapterus auratus</i> <i>Diapterus rhombeus</i>	Opportunist/Omnivore
18 Snapper	Lutjanidae	<i>Lutjanus jocu</i>	Piscivorous/Zoobenthivore
19 <i>Sciades herzbergii</i>	Ariidae	<i>Sciades herzbergii</i>	Zoobenthivore/Carcinophago
20 Other Catfish	Ariidae	<i>Aspistor luniscutis</i> <i>Aspistor quadriscutis</i>	Omnivore
21 Drum	Sciaenidae	<i>Bairdiella ronchus</i> <i>Menticirrhus americanus</i>	Zoobenthivore
22 Grunt	Haemulidae	<i>Conodon nobilis</i> <i>Pomadasys crocro</i>	Piscivorous/Zoobenthivore
23 Croaker	Sciaenidae	<i>Micropogonias furnieri</i>	Opportunist/Omnivore
24 Snook	Centropomidae	<i>Centropomus undecimalis</i> <i>Centropomus parallelus</i>	Piscivorous/Zoobenthivore
25 Jack	Carangidae	<i>Caranx hippos</i> <i>Caranx latus</i>	Piscivorous

The values of B, PB, QB and capture for all groups (Table 2) showed that only one component, Bivalves, represent more than a half of total biomass while total fish biomass represents 10% of total biomass, with fishing activities catching around 20% of this amount. High EE values were reported for most groups (e.g Polychaetes, Herring, Anchovies, *Eucinostomus* spp., Grunt, Croaker), mainly due to the high biomass of their

main predators (e.g *Sciades herbergii* - B: 4.57 t.km<sup>-2</sup>; Snook - B: 2.57 t.km<sup>-2</sup>; *Diapterus spp* - B: 1.61 t.km<sup>-2</sup>), however the EE of Snapper (EE: 0.06), Jack (EE: 0.15) and Bivalves (EE: 0.13) were considerably lower than other groups, since they are not heavily predated within this ecosystem (Table 2). The EE values of the groups targeted by fishing activities ranged between 0.3 – 0.35. Table 3 shows the diet matrix used in the model. The pedigree index and the measure of fit for SRE model were 0.34 and 1.754, respectively.

Table 2 Basics inputs and estimated outputs (bold) for the trophic groups for the model of the Estuary of Sirinhaém River, Northeast Brazil. TL: trophic level; B: biomass; P/B: production–biomass ratio; Q/B: consumption–biomass ratio; EE: ecotrophic efficiency; P/Q: production–consumption ratio; Y: landings; OI: Omnivory Index; PN: Path Number. Values in bold are estimated from the model.

	Group name	TL	B (t.km <sup>-2</sup> )	P/B (per year)	Q/B (per year)	EE	P/Q	OI	PN	Y
1	Phytoplankton	1.00	2.22	652.71	-	<b>0.58</b>	-	-	-	-
2	Zooplankton	2.00	<b>1.01</b>	50.21	150.65	0.90	<b>0.33</b>	-	1	-
3	Epiphyton	1.00	1.37	153.31	-	<b>0.69</b>	-	-	-	-
4	Microphytobenthos	1.00	<b>4.43</b>	209.61	-	0.50	-	-	-	-
5	Fiddler crabs	2.03	16.00	7.30	31.89	<b>0.51</b>	<b>0.23</b>	0.0338	9	-
6	Polychaetes	2.16	2.87	2.91	17.26	<b>0.88</b>	<b>0.17</b>	0.1366	7	-
7	Bivalves	2.00	90.00	2.00	9.00	<b>0.14</b>	<b>0.22</b>	-	2	-
8	Gastropods	2.01	17.60	2.65	38.83	<b>0.42</b>	<b>0.07</b>	0.0095	3	-
9	Blue crab	2.24	<b>3.74</b>	2.00	8.00	0.76	<b>0.25</b>	0.1869	34	-
10	Shrimp	2.30	<b>4.29</b>	2.81	26.90	0.95	<b>0.10</b>	0.2112	25	-
11	Herring	2.50	0.32	1.97	18.34	<b>0.83</b>	<b>0.11</b>	0.25	2	-
12	Anchovies	2.00	0.02	2.23	90.39	<b>0.80</b>	<b>0.02</b>	-	1	-
13	Mullet	2.02	<b>2.03</b>	1.88	43.15	0.35	<b>0.04</b>	0.0151	5	0.971435
14	Flatfish	2.97	0.91	3.16	13.43	<b>0.32</b>	<b>0.24</b>	0.2439	81	-
15	Puffer	2.72	0.87	3.17	11.06	<b>0.53</b>	<b>0.29</b>	0.2618	50	-
16	<i>Eucinostomus</i> spp.	2.89	0.03	1.33	12.84	<b>0.81</b>	<b>0.10</b>	0.2114	57	-
17	<i>Diapterus</i> spp.	2.72	1.61	2.90	10.61	<b>0.22</b>	<b>0.27</b>	0.2609	39	0.2962
18	Snappers	3.16	0.07	0.33	6.43	<b>0.06</b>	<b>0.05</b>	0.0465	391	-
19	<i>Sciades herzbergii</i>	2.85	4.57	1.38	9.94	<b>0.24</b>	<b>0.14</b>	0.1568	74	0.89676
20	Other Catfish	2.90	1.80	1.13	12.50	<b>0.41</b>	<b>0.09</b>	0.2076	124	0.16835
21	Drum	3.15	0.15	1.73	9.44	<b>0.47</b>	<b>0.18</b>	0.041	80	-
22	Grunt	3.25	0.12	0.93	8.79	<b>0.87</b>	<b>0.11</b>	0.073	311	-
23	Croaker	2.21	0.43	0.21	6.90	<b>0.97</b>	<b>0.03</b>	0.1972	32	-
24	Snook	3.20	2.57	1.68	5.70	<b>0.18</b>	<b>0.29</b>	0.2492	2054	0.78123
25	Jack	3.28	0.23	0.47	6.66	<b>0.15</b>	<b>0.07</b>	0.1862	1123	-
26	Detritus	1.00	2.76	-	-	<b>0.49</b>	-	-	-	-

Table 3 Diet composition matrix for the functional groups in the Estuary of Sirinhaém River, Northeast Brazil. Were: the numbers represented the groups of the model.

Prey	Predators																						
	2	5	6	7	8	9	10	11	12	13	14	15	16	17	18	19	20	21	22	23	24	25	
1 Phytoplankton	1.0000		0.1087	0.8000			0.1439	0.5000	1.0000	0.1539													
2 Zooplankton			0.1522			0.0161	0.2009	0.5000		0.0154	0.0061	0.0233	0.2269	0.4129				0.0631		0.0072	0.0568	0.0864	
3 Epiphyton		0.1500			0.0366	0.0368				0.4618			0.0422	0.0590									
4 Microphytobenthos			0.3261		0.5843	0.2666	0.1499			0.2309	0.1516		0.0422	0.0590									
5 Fiddler crabs							0.0179				0.0400	0.0500	0.0005		0.4231	0.8170	0.6511	0.4044	0.0100			0.2498	0.1640
6 Polychaetes							0.0050				0.2600		0.4600	0.2000				0.0073					
7 Bivalves		0.0291				0.1558	0.0270					0.1810					0.0005		0.0100	0.0521	0.0145	0.0200	
8 Gastropods			0.0109		0.0094	0.0644	0.0454				0.0600	0.2277	0.0219	0.0012	0.0020	0.0015	0.0227	0.0005	0.0100	0.0500	0.0285	0.0062	
9 Blue crab											0.0172	0.1922	0.0844		0.1759	0.0030	0.0424	0.0506			0.1566	0.0330	
10 Shrimp						0.0052					0.4171			0.0590	0.3602	0.0006	0.0500	0.4560	0.8837	0.0780	0.1000	0.3926	
11 Herring															0.0070	0.0008			0.0300		0.0310	0.0042	
12 Anchovies																			0.0060			0.0023	
13 Mullet																						0.0250	0.0002
14 Flatfish																				0.0030		0.0550	0.0722
15 Puffer																	0.0493		0.0030		0.0170	0.0650	
16 <i>Eucinostomus</i> spp																			0.0030		0.0019	0.0001	
17 <i>Diapterus</i> spp															0.0089						0.0470	0.0200	
18 Snappers																							0.0010
19 <i>Sciades herzbergii</i>															0.0005							0.0430	
20 Others Catfish															0.0005							0.0450	
21 Drum															0.0049				0.0013		0.0065	0.0150	
22 Grunt																						0.0042	0.0220
23 Croaker																						0.0050	0.0100
24 Snook																							0.0011
25 Jack																							0.0011
27 Detritus		0.8121	0.4022	0.2000	0.3698	0.4551	0.4100			0.1381	0.0480	0.3259	0.1220	0.2090	0.0170	0.1770	0.1841	0.0180	0.0400	0.8127	0.0890	0.0450	
28 Import																						0.0210	0.0430
Total	1	1	1	1	1	1	1	1	1	1	1	1	1	1	1	1	1	1	1	1	1	1	1

*Food web structure and trophic analysis*

*Trophic structure*

Trophic level (TL) varied from 1 (Primary production groups) to 3.28 (Jack) (Table 2), with mean (excluding primary production) of 2.57 (Fig. 4). Carnivorous fish such as Jack (3.28), Grunt (3.24), Snook (3.20), Snappers (3.16) and Drum (3.14) occupied the top trophic level. Except for primary producers and detritus, almost all the groups showed  $TL > 1 < 3$  in the SRE ecosystem.

Although top predators (Snook and Jack) have a larger number of paths, their omnivory index (OI) values were lower than the observed for Diapterus and Puffer (TL = 2.72) showing that omnivory could happen with a fewer number of paths and in a lower trophic level.

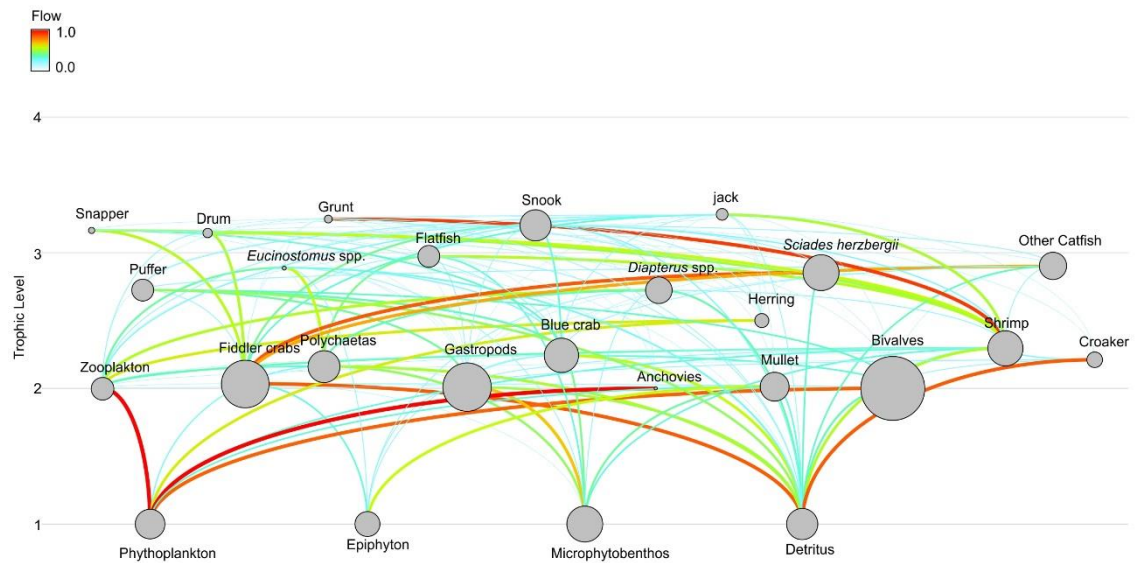

Figure 4. Schematic diagram of energy flow representing the food web structure of the Estuary of Sirinhaém River, Northeastern Brazil. The color lines denote energetic flow from are group to another (Red – High flow and White – Low flow). Different sizes of the circles indicate the different biomass ( $t\ km^{-2}$ ) of the components in trophic levels 1, 2, 3 and 4.



Transfer efficiencies

The Lindeman spine (Fig. 5) shows discrete trophic levels and highlights that 60.5% of the whole energy and matter ( $1,450 \text{ t km}^{-2} \text{ y}^{-1}$ ) flows through the grazing food chain, while only 39.5% ( $945.4 \text{ t km}^{-2} \text{ y}^{-1}$ ) flows in the detritus-based food chain. The TE was higher in a grazing food chain when compared to the detritus-based food chain (Table 4). Only 6.40% of the PP flowed to the trophic level II, the remaining returned to the detritus. The largest TE was observed between trophic level III and IV (9.82%) while the largest proportion of biomass of the system and contribution to detritus was concentrated in the TL II and TL I ( $138 \text{ t km}^{-2}$  and  $1,138 \text{ t km}^{-2} \text{ y}^{-1}$  respectively) (Fig. 5). The mean transfer efficiency was 6.06% from detritus and 7.18% from the primary producers, while the average trophic transfer efficiency for the entire system as a whole was 6.79% (Table 4)

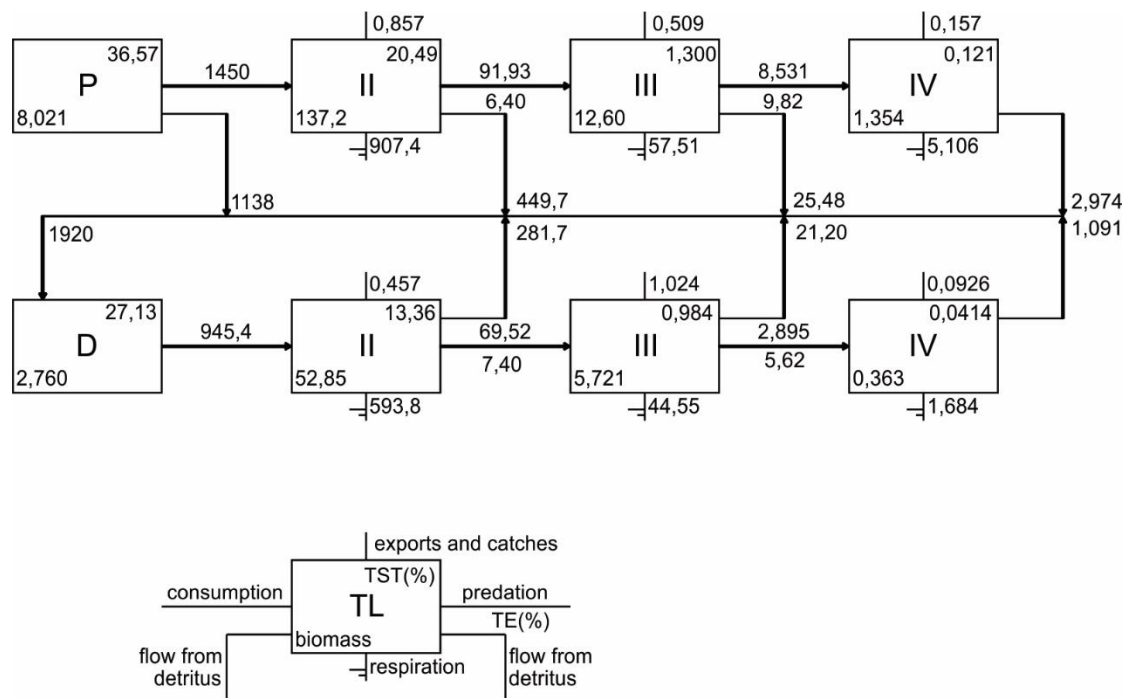

Figure 5. Trophic flows of the Estuary of Sirinhaém River, Northeastern Brazil by integer trophic levels (TL) in the form of the Lindeman spine. P and D represent the primary production and detritus, respectively, while the values in boxes indicate the biomass, import and percentage of total system throughput (TST) for each trophic level (TL). The values above and below arrows exhibit the efficiency of energy transfer (TE) through each trophic level.

*Mixed trophic impacts (MTI) and Keystone species*

The result of MTI exhibited both direct and indirect impacts of all groups of the system, for example, an increasing of 20% in the Snook biomass would have negative effects (red blocks) upon most of the groups in SRE ecosystem, but positive effects (blue blocks) on Snapper and Polychaetas (Fig. 6). However, fishery showed relatively strong negative effects on Snook and Mullet group (MTI= -0.647 and MTI= -0.325), but was beneficial for most groups, except the Snapper (MTI= -0.629). Because of a high biomass and predation rate, Bivalves and Gastropods presented direct negative impact in Phytoplankton (MTI= -0.437) and Microphytobenthos (MTI= -0.454) respectively. Other relevant impacts are caused by high predation rates. However, the highest negative or positive effect was observed in Snapper group as a result of the changes in Jack biomass (e.g. increase or decrease biomass of the Jack group – negative effect (MTI= -0.974) and positive effect (MTI= 0.913) in biomass of the Snapper, respectively) (Fig. 6).

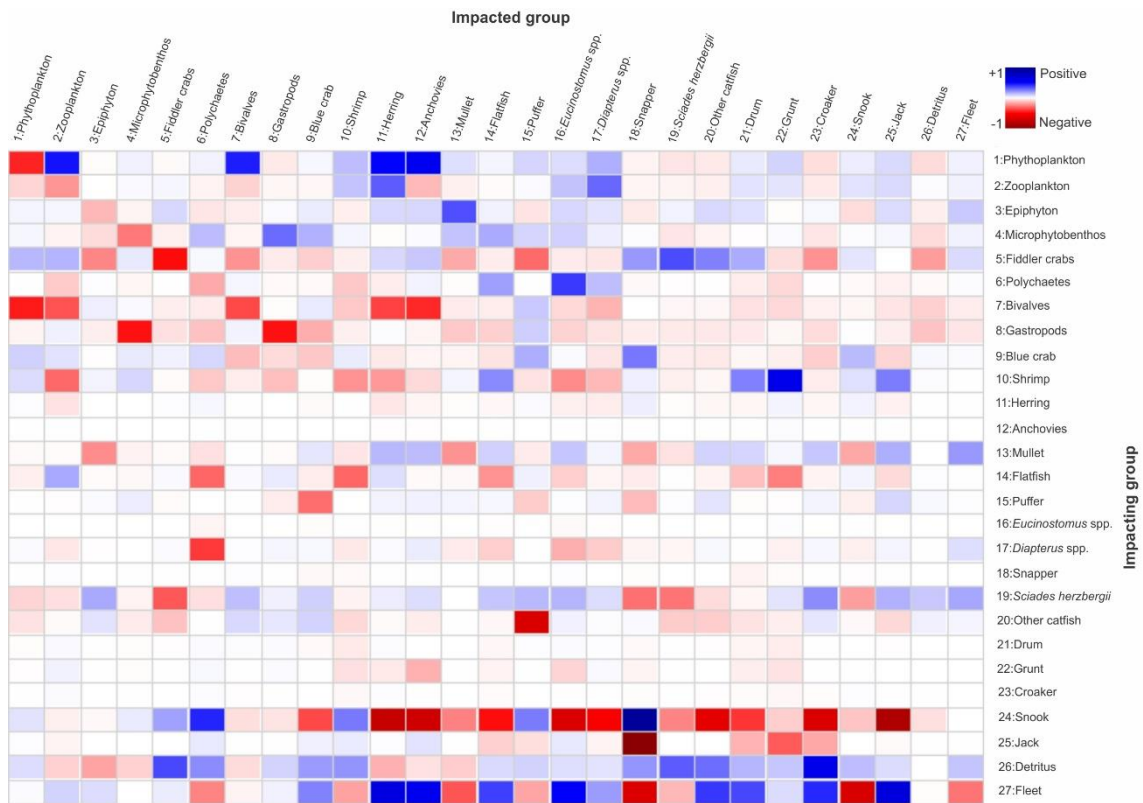

Figure 6. Mixed trophic impact (MTI) of the Estuary of Sirinhaém River, Northeastern Brazil. The color box shows negative (red) or positive (blue) impacts on the functional groups. The intensity of the color in the box are proportional to the degree of the impacts and its values range from -1 to +1.

Two groups of top predator show high KS3 rank values, Jack (KS<sub>i</sub>= 1.32; TL = 3.28) and Snook (KS<sub>i</sub>= 1.29; TL= 3.20), followed by the Phytoplankton (KS<sub>i</sub>= 0.99; TL= 1) and Flatfish (KS<sub>i</sub>= 0.94; TL= 2.97) (Fig. 7a). High values of Top-down effect (td) were associated with the Snook (td= 75%) and Jack (td= 99%), while Shrimp and Phytoplankton showed larger values of bottom-up effect (bu), (bu= 65% and bu= 84%, respectively). Only the Snook showed lower relative biomass and a higher impact in food chain compared to others groups (Fig. 7b). According to the MTI results and using the keystone species index, the Snook can be considered as the most important group in terms of relative total impact in the Estuary of the Sirinhaém River, although, Phytoplankton and Shrimp (Fig. 4) are important vectors for energetic transfer from food chain to top predators.

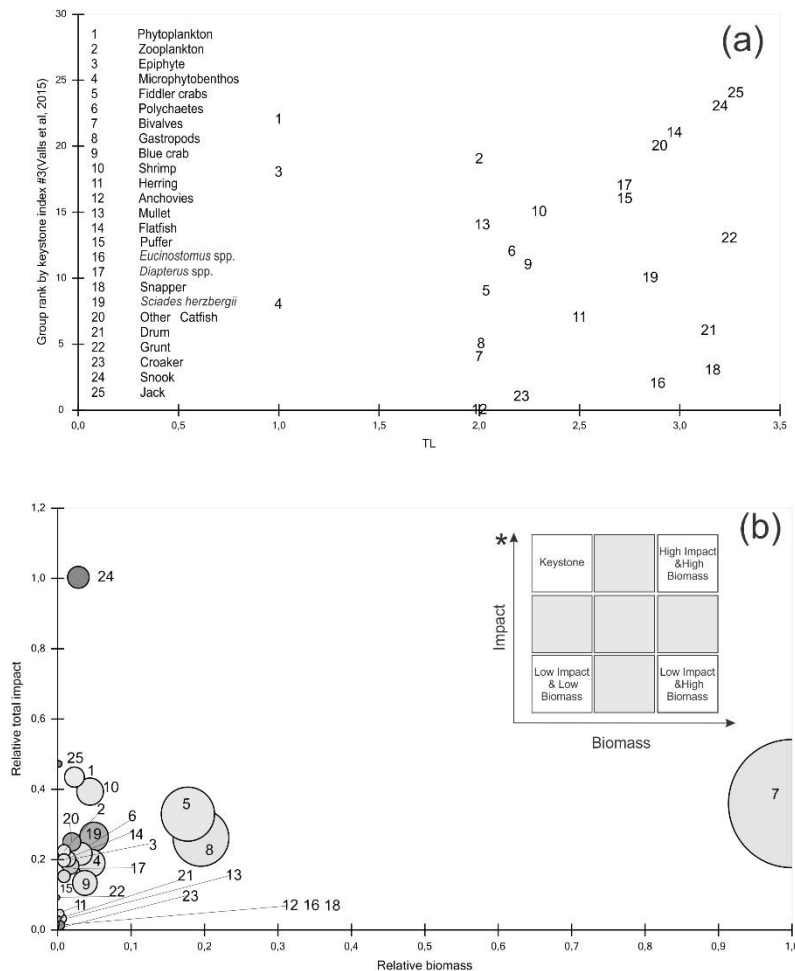

Figure 7. (a) Keystone index (axis Y) and relative total impact (axis X) of each compartment of the Estuary of Sirinhaém River, Northeastern Brazil. (b) Relationship between relative total impact (axis Y) and relative biomass (axis X). Number and circle size indicates the name and percentage relative biomass of each group. \* Conceptual identification of keystone species in food-web (VALLS et al., 2015).

### *Ecosystem properties and indicators*

The summary statistics and flow indices of the SRE ecosystem is given in Table 4. The total system throughput was  $7,083 \text{ t km}^{-2} \text{ y}^{-1}$ , 36% and 23% were due to consumption ( $2,575 \text{ t km}^{-2} \text{ y}^{-1}$ ) and respiratory process ( $1,610 \text{ t km}^{-2} \text{ y}^{-1}$ ), respectively. A total of 14% was derived from export ( $978 \text{ t km}^{-2} \text{ y}^{-1}$ ) and 27% of detritus ( $1,920 \text{ t km}^{-2} \text{ y}^{-1}$ ), as a result of the backflows in the ecosystem. The ratio of total primary production to total respiration (TPP/TR) was 1.6 and the ratio of total primary production to total biomass (TPP/TB) was 16.25. The sum of all production (TP) was  $3.038 \text{ t km}^{-2} \text{ y}^{-1}$ , and the total net primary production (TNPP) and the net system production (NSP) were  $2.587 \text{ t km}^{-2} \text{ y}^{-1}$  and  $977 \text{ t km}^{-2} \text{ y}^{-1}$ , respectively. The mean trophic level of the catch was estimated as 2.66, and the gross efficiency (catch/net primary production) was 0.001 in the SRE ecosystem. Overall, in the SRE ecosystem, the values of flow indices, i.e., CI and SOI, were estimated as 0.245 and 0.12 respectively; while the FCI and Finn's mean path length (FML) calculated by the model were 5.79% and 2.73, respectively (Table 4). The values of ascendancy and overhead were 27.89% and 72.11% respectively (Table 4).

### *Analysis of Fisheries*

Overall, the scenarios (increase and decrease of the fishing effort), caused a small variation in the different attributes analyzed (Biomass, L index, psust, Kempton's and TL catch). Compared with the baseline scenario, the total biomass of the groups in the ecosystem showed an increase of 0.07 – 1.04% over scenarios of increased fishing and reduction of 0.06 - 0.53% with the decrease fishing. The biomass of fish was reduced with elevation of fishing; however, invertebrates, primary production (PP) and detritus biomass increased; the opposite was registered with the decrease of the fishing effort (Fig. 8).

The Total Primary Production Required (TPPR) for maintenance of production of the groups in ecosystem ranged from  $8,535$  to  $9,086 \text{ t km}^{-2} \text{ y}^{-1}$ . The relation between TPPR and P1, showed the highest value of 63% into the worst scenario of increased fishing (F0x2), while the lower value was obtained with the simulation without fishing (58%) (Table. 5).

Table 4. Ecosystem attributes, ecological and flow indicators of the food web structure of the Estuary of Sirinhaém River, Northeastern Brazil. \* Rate of the Sum of all consumption, exports, respiratory flows and flows into detritus, in relation the total system throughput.

Parameters	Value	Units			
<b>Ecosystem properties</b>					
Sum of all consumption (TC)*	2,575.322 (0.364)	t.km-2.y-1			
Sum of all exports (TE)*	978.046 (0.138)	t.km-2.y-1			
Sum of all respiratory flows (TR)*	1,610.220 (0.227)	t.km-2.y-1			
Sum of all flows into detritus (TD)*	1,920.327 (0.271)	t.km-2.y-1			
Total system throughput (TST)	7,083.915	t.km-2.y-1			
Sum of all production (TP)	3,037.931	t.km-2.y-1			
Mean trophic level of the catch (TLc)	2.669	-			
Gross efficiency (catch/net p.p.)	0.001	-			
Calculated total net primary production (TNPP)	2,587.893	t.km-2.y-1			
Net system production (NSP)	977.673	t.km-2.y-1			
Total biomass (excluding detritus) (TB)	159.273	t.km-2			
Total catch (Tc)	3.114	t.km-2.y-1			
<b>Ecosystem maturity</b>					
Total primary production/total respiration (TPP/TR)	1.607	-			
Total primary production/total biomass (TPP/TB)	16.248	-			
Total biomass/total throughput (TB/TST)	0.022	y-1			
<b>Food web structure</b>					
Connectance Index (CI)	0.245	-			
System Omnivory Index (SOI)	0.119	-			
Finn's cycling index (FCI)	5.799	% of total throughput			
Finn's mean path length (FML)	2.737	-			
Ascendancy (A)	27.89	%			
System overhead (O)	72.11	%			
<b>Model reability</b>					
Ecopath pedigree index	0.343	-			
Measure of fit (t*)	1.754	-			
<b>Transfer efficiency</b>					
		TL			
		II	III	IV	V
Producer	6.400	9.823	5.907	4.835	
Detritus	7.403	5.624	5.358	4.742	
All flows	6.796	8.014	5.767	4.821	
Proportion of total flow originating from detritus: 0.42					
Transfer efficiencies (calculated as geometric mean for TL II-IV)					
From primary producers: 7.18%					
From detritus: 6.06%					
Total: 6.79%					

Table 5. Estimates of ecological indicators for maintenance of production of the groups in the Estuary of Sirinhaém River, Northeastern Brazil.

	Present situation	Increased fishing	Decreased fishing
	F0	F0x2	No fishing
P1 = PP + Flow to Detritus	4,508.23	4,522.57	4,493.55
Total Primary Production Required – TPPR (t.km-2.y-1)	7,264.48	7,140.23	7,728.39
P1/TPPR (%)	62	63.3	58.1
L' index	0.0054	0.01357	-
Fishery sustainability – psust	0.94	0.867	-

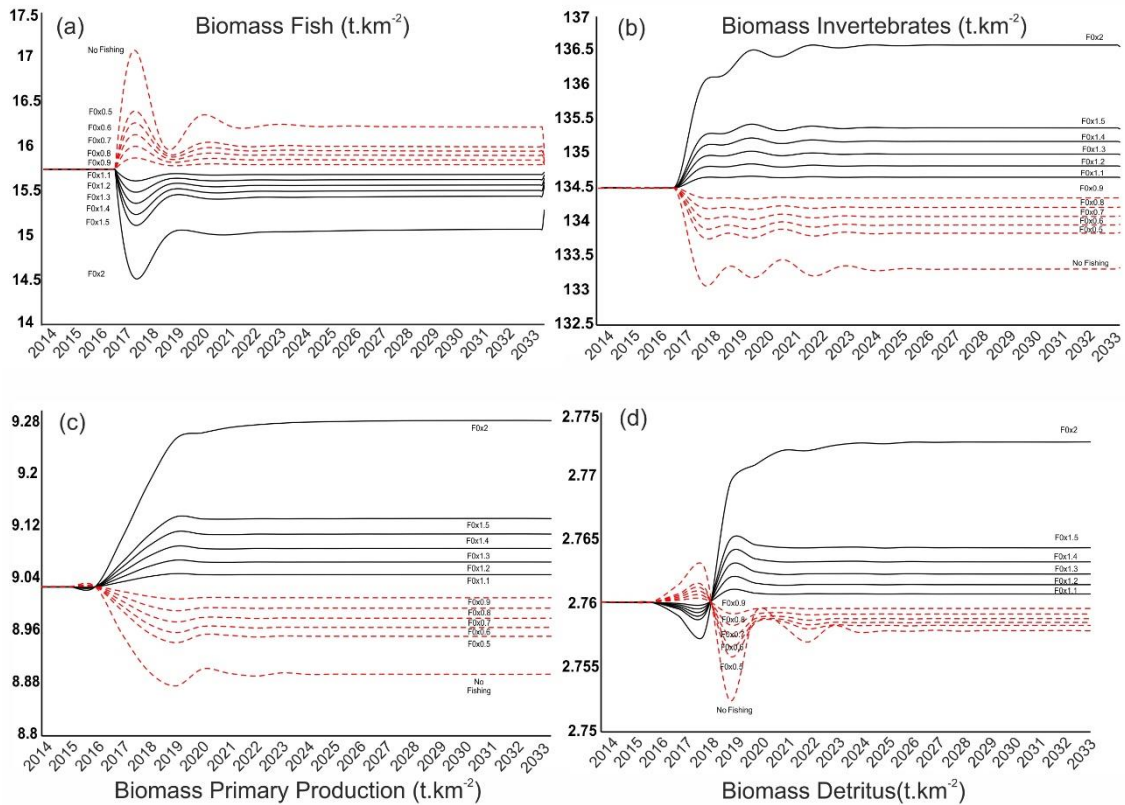

Figure 8. Changes in the biomass from Ecosim model, for different organisms (a. Fish, b. Invertebrates, c. Primary production – PP and d. Detritus) between 2014 and 2033 of the Estuary of Sirinhaém River, Northeastern Brazil. The black solid line and red dash line correspond to the simulations of increase and decreased of the fishing mortality, respectively.

The increased fishing mortality in the simulations raised the L index values, but even with the increased L index values, the fishery remains with sustainable levels, i.e., according to the index  $P_{sust}$  (Fig. 9a). When the sustainability of fishery for each target resource of the fishery is analyzed, the mullet group showed the higher reduction of

probability to be sustainably fished with the increased fishing mortality, decreasing below of 70%, being the threshold of sustainability of fishery ( $psust = 75\%$ ). In other groups, the ( $psust$ ) values remained over than 75%, with the lowest recorded for the Snook group ( $psust = 86\%$ ) (Fig 9b).

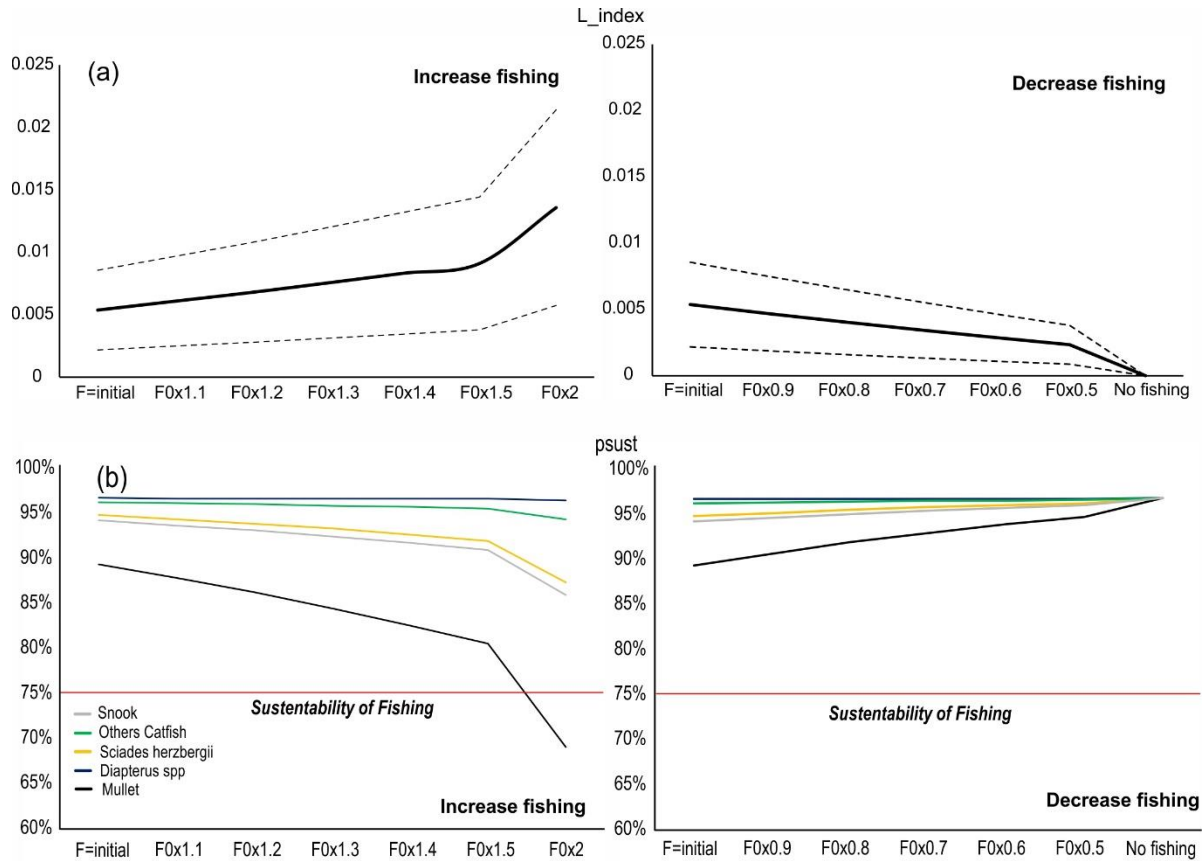

Figure 9. Ecological indicators (a)  $L$  index and (b) estimated probability to be sustainably fished ( $psust$ ) based on the increase and decrease values of fishing mortality of the Estuary of Sirinhaém River, Northeastern Brazil.

The biodiversity indicator, the Kempton's  $Q$  index, showed increase and decrease in response to increase and reduction of fishing mortality respectively (Fig. 10a), indicating that fishing activity improved the biodiversity evenness in ecosystem. It was observed a significant elevation or reduction of  $Q$  index after the initial periods with the fishing constant, in the simulations of increase and decrease fishing mortality respectively, followed of a stabilizing until the end of the simulation period (Fig. 10a). The lower level of evenness is attained when fishing mortality is reduced to 0 (No fishing), indicating the importance of these resources into the control of the food web, mainly the snook group, considered as a key species in the system.

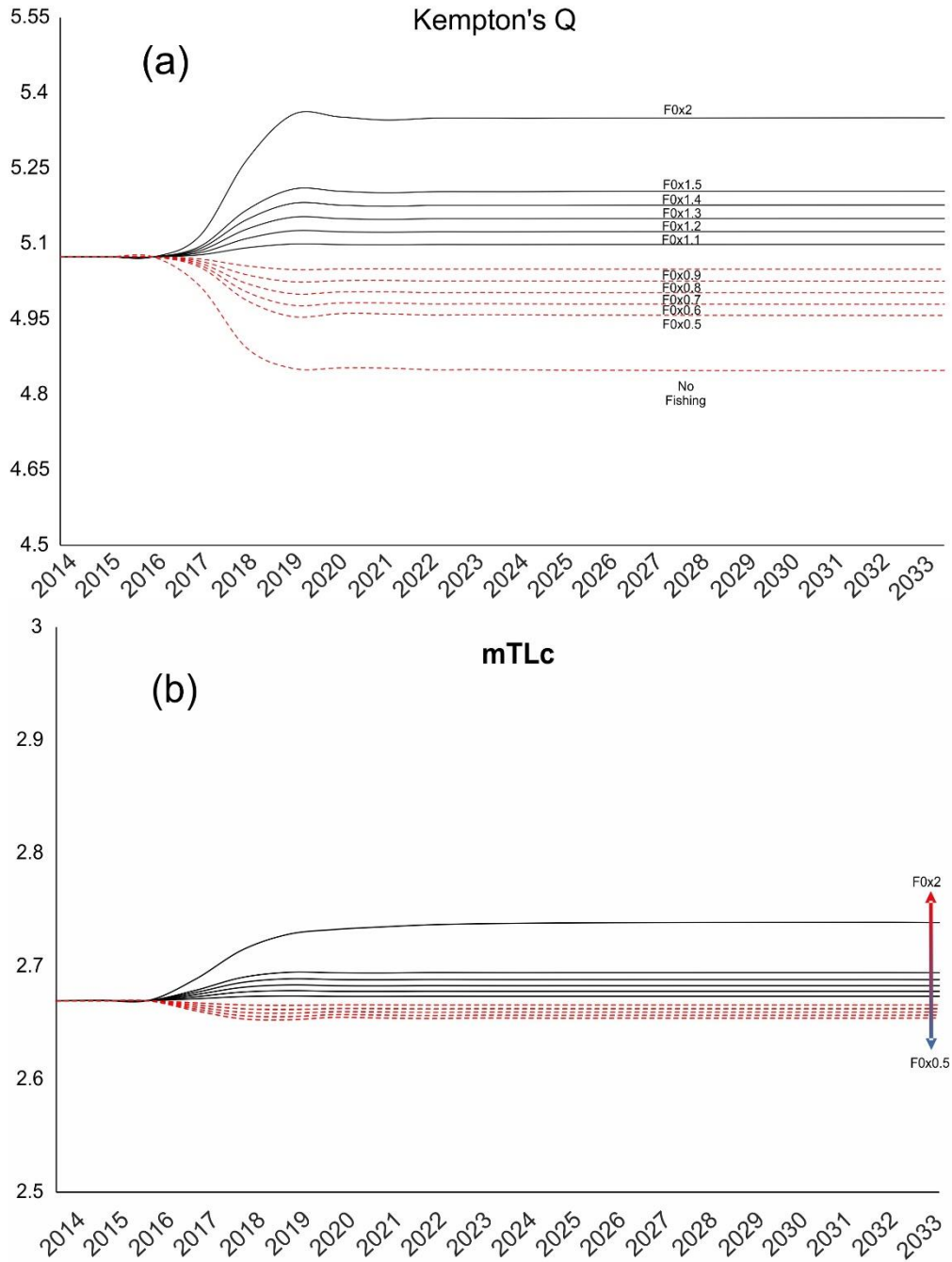

Figure 10. (a) Kempton's index and (b) mean trophic level catch (mTLc) estimated from variation of the values of fishing mortality between 2014 and 2033 of the Estuary of Sirinhaém River, Northeastern Brazil. The black solid line and red dash line correspond to the simulations of increased and decreased mortality, respectively.

There was a general increasing trend of mTLc with Q index over time with the increasing of the fishery and a decreasing trend in response to the reduction of the fishing mortality (Fig. 10b). In general, the simulations with high fishing pressure resulted in the increased of removal of the species/group of low trophic level (mullet (TL: 2.01)), which probably would cause a reduction in mTLc. However, the increase of the fishing



mortality, also caused the increase of catch of the species/group of high trophic level (e.g. Snook (TL: 3.20); *Sciades herzbergii* (TL: 2.85) and Others Catfish (TL: 2.90)), elevate the mTLc (Fig. 10b).

## **Discussion**

### *Food web structure in SRE ecosystem*

Estuarine ecosystems are classified as ideal habitats in tropical, subtropical and temperate regions for numerous marine and freshwater resources, constituting an essential system (PREMCHAROEN and PATHOM, 2014; COUILLARD et al., 2017); but also susceptible to a number of anthropogenic interference, for example, through industrial activities and fishing (BLABER, 2011; VIANA et al., 2012; ECOUTIN et al., 2014), which may cause changes in the food chain (BLABER, 2013).

In this study, it was developed a trophic model for a tropical estuary in Brazil. Estuarine trophic models are extremely rare in the tropics. This is mainly due to the absence of historical data and/or basic information on ecology and biology of the ecosystems and living resources, which is the case of Brazil (ANGELINI e GOMES, 2008). This model has strong and weak points. An intensive data collection of the main consumers was carried out. The diet of the main consumers was also obtained for the studied area. These were the main strong points. However, other groups, such as the primary production and zooplankton, were obtained from the literature. Yet, the pedigree value, which evaluate the robustness of the model, was within the a range established by Morissette et al. (2006), who evaluated the pedigree values of over 150 Ecopath models published (values between 0.164 and 0.675). The application of the catchability model was also a weak point of our model. Catchability, which is a key parameter in fishery stock assessment, is a concept in fishery biology which reflects the efficiency of a particular fishery. Its quantitative magnitude is expressed by the catchability coefficient, which relates the biomass abundance to the capture or fishing mortality (ARREGUIN-SANCHEZ, 1996). This parameter is used given the problematic of the underestimation of fish biomass due to gear selectivity in the Ecopath models (SIMON and RAFFAELLI, 2016; BENTORCHA et al., 2017). Some authors have chosen to, in the absence of catchability coefficients to correct biomass estimates, attributing maximum values to ensure mass-balance (CORRALES et al., 2017). In our study, we used the approach proposed by Laretta et al. (2013). Given the absence of some information, we adopted

the coefficient considering the similarity of our species with those of the author, considering the alike genus, body and/or fin format. Nevertheless, the occasional misuse of this parameters (or the decision of not using it) may cause the sub or overestimation of the biomass of some compartments. Finally, as a transitory habitat, estuaries are considered as open environments, and subject to variations of others habitats through recruitment, and a complex trophic structure, including apex predators (MAHONEY and BISHOP, 2017). Hence, given the difficulty of estimating the known connectivity amongst coastal areas, the assumption that there was no net migration with the model is here assumed as for other estuarine ECOPATH models (PATRÍCIO and MARQUES, 2006; HAN et al., 2016). Inclusion of a biomass accumulation factor and migration factor in the general Ecopath equation distinguishes Ecopath modelling as an ‘energy continuity’ approach rather than a strictly ‘steady-state’ approach (PATRÍCIO and MARQUES, 2006).

Most of the biomass in SRE was derived from invertebrates, followed by the fishes, mainly Mulletts, Catfishes and Snook that showed higher biomass. The high biomass of invertebrates in tropical systems, particularly in estuaries, are important components as supporters of food web, providing links between primary producers and higher trophic levels (MCQUAID and GRIFFITHS, 2014; SHEAVES et al., 2016), while the relatively high biomass of the top predators can produce a predation pressure on forage species through the top-down control in the food web (WASSERMAN et al., 2013; DU et al., 2015).

The trophic level value of groups on SRE was lower when compared to those observed by Villanueva (2015) in estuarine ecosystems of the Senegal in the African. Dimension of the habitat, evenness, changes in the flux of nutrients, fishery and diet are only a few of the aspects that influence the estimates of the trophic level (PASQUAUD et al., 2010; XIA and TABETA, 2016). The omnivory index (OI) was low compared to that obtained in other estuarine systems (TECCHIO et al., 2015); indicating prey specialization for the majority of the groups. Usually, in tropical environments (e.g. estuaries), most of the fish species tend to be generalists or opportunists (KROETZ et al., 2016; PEREIRA et al., 2017), a consequence of the high biodiversity in these systems (PEREIRA et al., 2012). Low values of Omnivory Index (OI) may be an effect of a reduction of the trophic niche for functional groups with lower or similar TLs, both consequently causing reduction of the OI of their predators. The diversity of prey can be

another important factor for the low values of OI. Sirinhaém showed lowest levels of functional diversity and species richness when compared to others estuarine zones of Pernambuco, Northeastern Brazil, which could be associated to the local environmental geomorphology (SILVA-JÚNIOR et al., 2016). This region has a large inner region and a narrow outermost area (SILVA et al., 2011); that can influence the flux of water, transport of larvae, nutrients and organisms between the coast and the estuary (LAYMAN et al., 2007), contributing for the lowest levels of functional diversity and species richness.

The % Total System Throughput-TST was high in TL I, where most is due to PP. The mean transfer efficiency (TE: 6.79) was relatively low compared to the theoretical value of 10% assumed by Lindeman (1942), indicating low global transfer efficiency. However, it is within the range reported in various estuarine trophic models (DE MUTSERT et al., 2012; LERCARI et al., 2015; ABDUL and ADEKOYA, 2016; HAN et al., 2016). Phytoplankton, Macroalgae, Microphytobenthos, Periphyton, and Seagrasses can be highly productive, and an important source of carbon for estuarine ecosystems (HYNDES et al., 2014). In our study, the larger contribution of PP to the food web is related to the importance of PP for secondary consumers as Bivalves, Fiddler crabs and Gastropods. The growth rate of primary production is determined by temperature, nutrient concentrations and light availability, and the rate of biomass change is determined by the balance between rates of growth and mortality including consumption by grazers as the bivalves, considered strong regulators of biomass primary production (CLOERN et al., 2014).

MTI analysis showed functional groups which were impacted negatively by Snook, and positively by fishery activity. Negative impacts can be associated to prevailing top-down effects whereas the positive ones can be associated to bottom-up effects (CHEN et al., 2015). The fishery activity causes a reduction in Snook biomass and consequently decrease the pressure of predation on their prey. Based in KS3 of the Ecopath, it was possible to observe that the Snook is a keystone species in SRE, presenting a high impact in the food web. Keystone species have strong influence on the abundance of other species and ecosystem dynamics (LIBRALATO et al., 2006; VALLS et al., 2015). Snooks are considered an important resource in SRE, both biologically (MERIGOT et al., 2016; SILVA-JÚNIOR et al., 2016) and economically (IBAMA, 2008). In a top-down control system, the top predators determine the bulk of the lower TLs through direct and indirect effects, as the predation and changes in their biomass, respectively (DINEEN and

ROBERTSON, 2010; TESTA et al., 2016). It was observed that some groups had a negative impact on themselves (e.g. Fiddler crabs and Gastropods), reflection of increasing cannibalism and competition for resources (COLL et al., 2006b; CHRISTENSEN et al., 2008).

*Analysis of fisheries in the ecosystem*

The scarcity of local information affects not only the region of SRE, but also all Brazilian territory and other underdeveloped countries, for instance Senegal (COLLÉTER et al., 2012). Other limitations include the lack of time-series of landing data, which hamper the calibration of the ecosystem dynamics, representing a limitation to the development of the Ecosim (HEYMANS et al., 2016). Thus, our simulations need to be considered with caution and as a first approximation of the effects of the changes of the fishery on the food web, making necessary complementary studies to analyze more precisely the effect of the fishing in ecosystem.

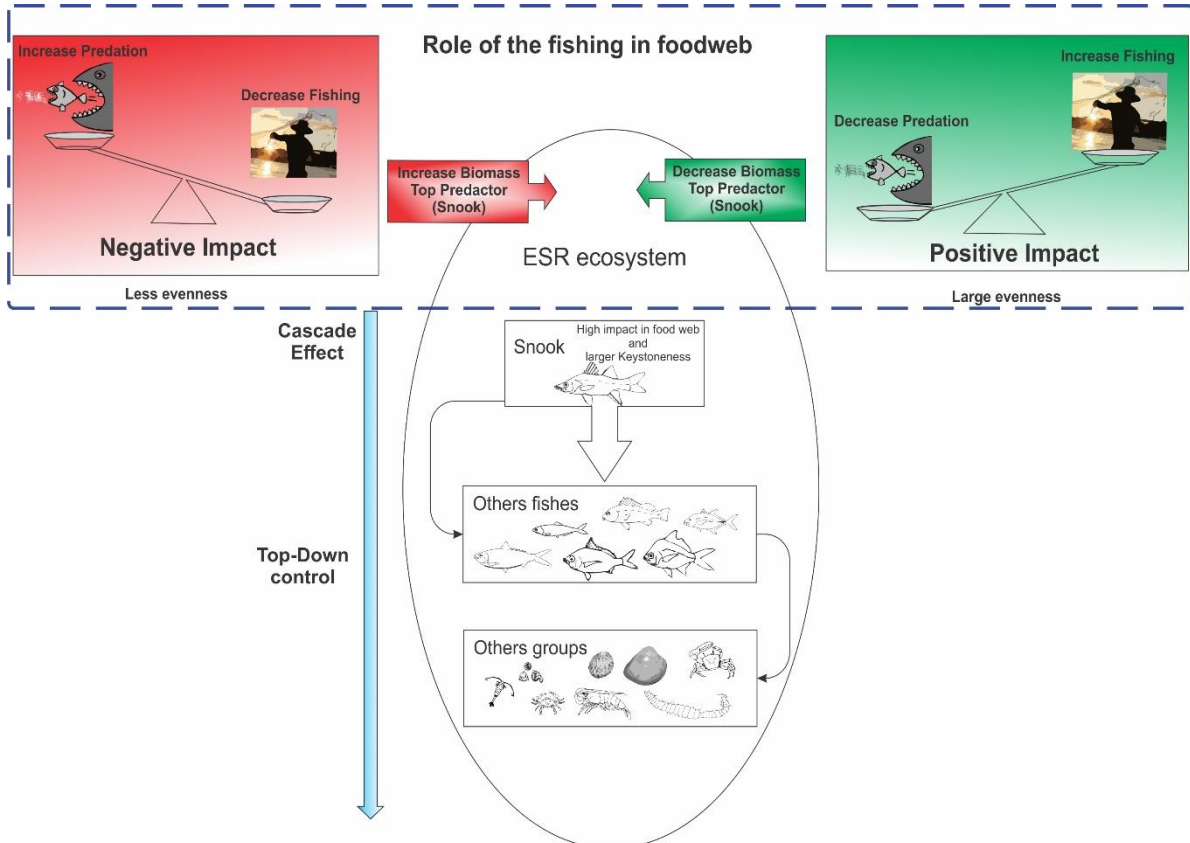

Figure 11. Conceptual model of the fishing effect in the Estuary of Sirinhaém River, Northeastern Brazil.

Compared with the basic model, the total primary production required (TPPR) to sustain the biomass production of the food web organisms, reduces with the increase of fishing, and increase with the decrease of fishing. This variation is the response of changes into the total biomass of fish in the ecosystem, for example, the higher biomass production of fish (decrease of fishing), require a higher TPPR. The Total Primary Production Required (TPPR) can return to detritus and enhance the recycling caused by the predatory species in the higher TLs, which results in values of TPPR that almost twice are higher than the P1 (Calculated Net Primary Production + Flows to Detritus) (ANGELINI et al., 2013). The reduction of TPPR can suggest a more efficient cycling of resources and a healthier state of the system, which can be associated with lower costs to ecosystem maintenance (HORNBORG et al., 2013).

A meta-analysis of the 51 classified models was conducted in order to develop the Psust index (LIBRALATO et al., 2008), a probability measure of sustainability, used in our study. Our results, shows that, in general, the increase of the effect of fishing in the simulations resulted in an increase of the mean L index values, nevertheless, the highest values of the L index that were obtained, were not sufficient to modify the probability of sustainable fishery ( $P_{sust}$ ). When each resource caught by the fishery activity is observed, the mullets showed values below sustainability. The increase of fishing intensity over time decrease their probability of being sustainably fished (HEYMANS et al., 2014). In terms of diagnostic of a changing intensity of the fishery, we may considerer this results with caution. This index may be used with different data: (1) mass-balance models, (2) calibrated dynamic ecosystem models, and (3) landings data sets. In the case of (1), which is our study case, the Lindex and psust were designed to be estimated for models not used for defining reference values and results should be evaluated in terms of coherence with partial information available (LIBRALATO et al., 2008). Inconsistencies which may emerge between available information and the results of this index may be attributed by the high degree of uncertainty embedded in the reconstruction of historical ecosystems (HEYMANS, 2003). Hence, given the fragility of the estuarine environment and the known impacts of the ESR, information regarding others sources and models, should be considered in order to corroborate with the results here observed.

The Kempton index and mean trophic level catch increased and decreased in response to the increase and reduction of fishing mortality respectively, indicating that the fishery has an important role on evenness of the ecosystem. This results are distinct

from those found by Wang et al. (2016) in Pearl River Estuary - China; Goldsworthy et al. (2013) in the Great Australian Bight - Australia; Lynam and Mackinson (2015) in North Sea and Ainsworth et al. (2011) in Northeast Pacific. Various factors can influence the increase of the mean trophic level catches (mTLC), as for example, the increase of the biomass of high trophic level stocks, the change in the fishing fleet (e.g. expansion of the fishing area) (KLEISNER et al., 2014), while the decrease in mTLC can be caused by an increase of the contribution of low-trophic-level species to landings rather than depletion of top predators (ESSINGTON et al., 2006). Our results can be explained by the little presence of species with key role in system (only snook), which implies in a low evenness and higher snook dominance. Therefore, the snook reduction due to fishing causes an increase of Kempton index and consequently a higher evenness in the ecosystem.

#### *Ecosystem health and comparison with other estuarine systems*

Based on ecological theories, Odum (1969) attested that the system omnivory index (SOI) and connectance index (CI), total system throughput (TST), ascendancy (A), relative ascendancy (A/C), System overhead (O), Finn's cycling index (FCI), the ratio of total primary production to respiration (TPP/TR) and total primary production to biomass (TPP/B) are important indicators to measure the complexity, stability and maturity of the system (VASCONCELLOS et al., 1997; TOMCZAK et al., 2013; HEYMANS et al., 2014). The mature ecosystem tends to have TPP/TR of nearly 1 and a low TPP/TB value (CHEA et al., 2016).

In this study, the ecological indicators which evaluate the state of the ecosystem were, in general, similar the other tropical ecosystems (see Tables 4 and 6), with some key differences. For example, the TPP/TB and overhead in our model was high, while FCI value was relatively low. The higher values of TPP/TB for the SRE are associated principally with low total biomass in the system compared to other systems. The high predatory cycling index value of the overhead, suggests a trend towards a more mature ecosystem and with a larger capacity of resilience (FINN, 1976; HEYMANS and BAIRD, 2000; GUO et al., 2013). The high overhead value in SRE, together with the different ecological indicators analysed, indicated that, SRE is in process of development with a good degree of stability. Estuaries are dynamic ecosystems (MEIRE et al., 2005) characterized by integrating marine, coastal and fluvial systems through water flows, sediment, dissolved substances and organisms, constituting a socio-ecological system (NICOLODI et al., 2009), with ecosystem services (BOEREMA and MEIRE, 2016).

Even within a single habitat or ecosystem unit, the concept of food webs implies in connectivity (SHEAVES, 2009). Because of the high dynamic of ecosystem and the constant environmental changes, most estuaries are considered as immature systems, i.e, in state of development (TECCHIO et al., 2015) and requiring management strategies to the maintenance for the equilibrium state (PALLERO FLORES et al., 2017).

Consumption, exports, respiratory flows, detritus flows, CI and SOI rate also were very similar amongst estuarine ecosystems (see table 4 and 6), even though these indicators are influenced by the size of the system. CI and SOI are the important indices used to describe the food web feature, high values reflecting the high diversity of diet composition while low values indicating a linear food web pattern rather than a web-like structure (HEYMANS et al., 2004; CHEA et al., 2016). TST total sum of flows within the system are here considered as an indicator of ecosystem size (RUIZ et al., 2016), therefore having positive relation with system size. Tropical estuaries and brackish ecosystems are constantly exposed to both long-term trends and rapid environmental changes (VILLANUEVA, 2015). These system are characterized by complex food webs (SCHARLER and BAIRD, 2005; BIRD et al., 2016). The levels of organization of the fish structure in these ecosystems, can also be complex due to seasonal variations, which can cause prey limitations and modification in the use of the habitat (CLOERN and JASSBY, 2012; MORRIS et al., 2015).

In our study case, the SRE shows a typical trophic structure of tropical estuarine system, with a large contribution of phytoplankton to the food web. Mixed Trophic Impact (MTI) analysis, Keystoneness index and the fishing showed that the snook cause a cascade effect (Top-Down), indicating that this species is a keystone species. Snook has a high socio-economic relevance for the region, although with an unregulated fishery in the region. The SRE is subject to a high impact mainly by sugar cane and other agribusiness industries, regardless of begin is located within two Marine Protected Areas (MPA), but with no management plan. Protected Areas are considered one of the best alternative to conservation of the ecosystem, protecting a representative portion of the environment through spatial closures to extractive practices such as the fisheries (MORMEDE et al., 2017). However, its effectiveness may be hampered if there is a lack of dialogue and communication between local and scientific knowledge to the decision-marking (GERHARDINGER et al., 2009), ending up with a MPA without management plan, and hence without effectiveness.

This study is an important contribution to trophic modelling in tropical estuarine ecosystem, being the starting point for others studies of Ecosystem Approach to Fisheries (EAF) in the region, based in an existing model. Ecopath with Ecosim (EwE) was among the first ecosystem-level simulation model to be freely accessible contributing to its worldwide uptake and popularity as a key tool for the ecosystem-approach to fisheries and marine resources (VILLASANTE et al., 2016). This approach not only requires a thorough understanding of the impact of fishing on ecosystem functioning and of the ecological processes involved, but also quantitative tools such as ecosystem models to provide useful information and predictions in support of management decision (OLIVEROS RAMOS et al., 2017). Also, it is widely considered to be a strategy for achieving sustainable delivery of marine ecosystem services (FRANCIS et al., 2011).

The present study is a first trophic model of the region and should be improved with complementary and more accurate information, which can help to understand the effect of fishery on the environments with more precision. Also, incorporating additional tools to the current model, such as Ecospace (ABDOU et al., 2016), which allows an spatial evaluation of the model and, more recently, “Value-Chain”, an economical “chain” of the resources (HALOUANI et al., 2016b), would allow useful insights of the effects of various management policies and the possible trade-offs at the ecosystem level.



Table 6. Ecological indicators of ecosystem health, in different tropical estuarine systems. For comparison of the different models, Sum of all consumption, exports, respiratory flows and flows into detritus were divided for Total system throughput.

Attributes	Mamanguape Estuary <sup>1</sup>	Caete Estuary <sup>2</sup>	Sine-Saloum estuary <sup>3</sup>	Gambia River estuary <sup>4</sup>	Cameroon Estuary <sup>5</sup>	Ogun State coastal estuary <sup>6</sup>	Bolong de Bamboung <sup>7</sup>	
Coordinates	06°46'20"S 34°56'00"W	0°58'18"S 46°56'52"W	13°59'57"N 16°37'5"W	13°46'20"N 16°05'05"W	3°54'53"N 8°34'26"E	6°29'09"N 4°06'28"E	13°39'34"N 16°31'23"E	
Geographic zone	Tropical	Tropical	Tropical	Tropical	Tropical	Tropical	Tropical	
Size (Km <sup>2</sup> )	-	220	543	654	1,750	26	4.7	
Depth (m)	4-8	<10	10-25	3-15	50	-	0-15	
Temperature (°C)	28	25.5-26.7	25	27	20.5	-	-	
Salinity (PSU)	1-37	-	45-130	38-45	-	-	36-140	
River flow range (m <sup>3</sup> .s <sup>-1</sup> )	-	-	-	4.5-1500	-	-	-	
Number of groups	24	19	37	41	26	14	31	
Main Objective	Evaluate maturity and keystone species in ecosystem, and the relation between estuarine and reef zones, and possible environmental impacts	Holistic picture of the Caete mangrove ecosystem	Describe the system structure and functioning of ecosystem (less exploited)	Describe the system structure and functioning of ecosystem (highly exploited system)	Describe and quantify structure and function of ecosystem, and mangrove biomass changes effects	Provides a snapshot of the estuarine community and mass balance fluxes using the Ecopath model	Assess the impact of a MPA on the entire trophic network using trophodynamic models	
Period of model	2011-2012	1970-1990	1991	2001	2010-2015	-	2003	2006-2008
<b>Ecosystem properties</b>								
Sum of all consumption (TC) - t.km <sup>-2</sup> .y <sup>-1</sup>	0.409	0.355	0.189	0.509	0.361	0.164	0.331	0.310
Sum of all exports (TE) - t.km <sup>-2</sup> .y <sup>-1</sup>	0.051	0.207	0.346	0.032	0.178	0.366	0.188	0.206
Sum of all respiratory flows (TR) - t.km <sup>-2</sup> .y <sup>-1</sup>	0.223	0.090	0.077	0.254	0.205	0.069	0.205	0.190
Sum of all flows into detritus (TD) - t.km <sup>-2</sup> .y <sup>-1</sup>	0.295	0.348	0.389	0.205	0.257	0.401	0.276	0.295
Total system throughput (TST) - t.km <sup>-2</sup> .y <sup>-1</sup>	7,764	10,559	27,938	2,585	18,615	34,385	6,138	5,867
Sum of all production (TP) - t.km <sup>-2</sup> .y <sup>-1</sup>	2,806	3,555	13,074	1,036	893	17,110	2,773	2,659
Mean trophic level of the catch (TLc)	2.42	2.08	2.59	3.10	-	-	2.73	3.13

Gross efficiency (catch/net p.p.)	0.003	0.085	0.001	0.004	-	-	-	-
Calculated total net primary production (TNPP) - t.km-2.y-1	2,127	3,134	11,815	658.51	7,105	-	2,411	2,321
Net system production (NSP) - t.km-2.y-1	-	558	9,677	81.54	3,294	12,598	1,151	1,207
Total biomass (excluding detritus) (TB) - t.km-2	4,227	13,132	260.96	53.39	184	181	132	127
Total catch (Tc) - t.km-2.y-1	7.46	268	12.06	3.36	-	-	-	-
<b>Ecosystem maturity</b>								
Total primary production/total respiration (TPP/TR)	1.23	3.31	5.52	1.12	1,865	6.33	1.91	2.08
Total primary production/total biomass (TPP/TB)	0.50	0.24	45.27	13.83	39	82.61	18.29	18.22
Total biomass/total throughput (TB/TST) - y-1	0.56	1.24	0.009	0.021	0.010	0.005	0.021	0.022
<b>Food web structure</b>								
Connectance Index (CI)	0.26	0.23	0.25	0.19	0.30	0.327	0.34	0.34
System Omnivory Index (SOI)	0.13	0.11	0.14	0.15	0.143	0.288	0.15	0.15
Finn's cycling index (FCI) - % of total throughput	24.80	17.90	2.68	14.99	2.000	1.700	3.54	3.66
Finn's mean path length (FML)	3.57	3.40	2.36	3.50	1.710	2.290	2.50	2.50
Ascendancy (A) - %	30.80	27.40	37.50	23.10	35	42.30	25.50	27.20
System overhead (O) - %	68.90	69.60	62.50	76.90	65	57.70	74.50	72.80

1- Xavier (2013); 2- Wolff et al. (2000); 3 and 4 - Villanueva (2015); 5 - Simon and Raffaelli (2016); 6 - Abdul and Adekoya (2016); 7 - Colléter et al. (2012).

## References

ABDOU, K.; HALOUANI, G.; HATTAB, T.; ROMDHANE, M. S.; FRIDA BEN; LE LOC'H, F. Exploring the potential effects of marine protected areas on the ecosystem structure of the Gulf of Gabes using the Ecospace model. **Aquatic Living Resources**, v. 29, n. 2, p. 202, 2016.

ABDUL, W. O.; ADEKOYA, E. O. Preliminary Ecopath model of a tropical coastal estuarine ecosystem around bight of Benin, Nigeria. **Environmental Biology of Fishes**, v. 99, n. 12, p. 909–923, 2016.

AINSWORTH, C. H.; PITCHER, T. J. Modifying Kempton's species diversity index for use with ecosystem simulation models. **Ecological Indicators**, v. 6, n. 3, p. 623–630, 2006.

AINSWORTH, C. H.; SAMHOURI, J. F.; BUSCH, D. S.; CHEUNG, W. W. L.; DUNNE, J.; OKEY, T. A. Potential impacts of climate change on Northeast Pacific marine foodwebs and fisheries. **ICES Journal of Marine Science: Journal du Conseil**, v. 68, p. fsr043, 2011.

ALBOUY, C.; MOUILLOT, D.; ROCKLIN, D.; CULIOLI, J. M.; LE LOC'H, F. Simulation of the combined effects of artisanal and recreational fisheries on a mediterranean MPA ecosystem using a trophic model. **Marine Ecology Progress Series**, v. 412, p. 207–221, 2010.

ALLEN, K. R. Relation Between Production and Biomass. **Journal of the Fisheries Research Board of Canada**, v. 28, n. 10, p. 1573–1581, 1971.

ANGELINI, R.; ALOÍSIO, G. R.; CARVALHO, A. R. Mixed food web control and stability in a Cerrado river (Brazil). **Pan-American Journal of Aquatic Sciences**, v. 5, n. 3, p. 421–431, 2010.

ANGELINI, R.; DE MORAIS, R. J.; CATELLA, A. C.; RESENDE, E. K.; LIBRALATO, S. Aquatic food webs of the oxbow lakes in the Pantanal: A new site for fisheries guaranteed by alternated control? **Ecological Modelling**, v. 253, p. 82–96, 2013.

ARREGUIN-SANCHEZ, F. Catchability: a key parameter for fish stock assessment. **Reviews in Fish Biology and Fisheries** 6, 221-242, 1996.

APAC. **Agência Pernambucana de águas e clima**. Disponível em: <<http://www.apac.pe.gov.br/meteorologia/monitoramento-pluvio.php>>.

BARBIER, E. B.; HACKER, S. D.; KENNEDY, C.; KOCK, E. W.; STIER, A. C.; SILLMAN, B. R. The value of estuarine and coastal ecosystem services. **Ecological Monographs**, v. 81, n. 2, p. 169–193, 2011.

BENTORCHA, A.; GASCUEL, D.; GUÉNETTE, S. Using trophic models to assess the impact of fishing in the Bay of Biscay and the Celtic Sea. **Aquatic Living Resources**, v. 30, p. 7, 2017.

BIRD, M.; PERISSINOTTO, R.; MIRANDA, N.; PEER, N.; RAW, J. Stable isotope analysis of consumer food webs indicates ecosystem recovery following prolonged drought in a subtropical estuarine lake. **African Journal of Marine Science**, v. 38, n. 3, p. 411–422, 2016.

BLABER, S. J. M. Removals (wild harvesting) of the biological resources from systems. In: WOLANSKI, E.; MCLUSKY, D. S. (Ed.). **Treatise on Estuarine and Coastal Science**. Waltham: Academic Press, 2011. p. 253–275.

BLABER, S. J. M. Fishes and fisheries in tropical estuaries: The last 10 years. **Estuarine, Coastal and Shelf Science**, v. 135, p. 57–65, 2013.

BOEREMA, A.; MEIRE, P. Management for estuarine ecosystem services: A review. **Ecological Engineering**, 2016.

BREY, T. Growth performance and mortality in aquatic macrobenthic invertebrates. **Advances in Marine Biology**, v. 35, n. January 1999, p. 153–223, 1999.

CÁCERES, I.; ORTIZ, M.; CUPUL-MAGAÑA, A. L.; RODRÍGUEZ-ZARAGOZA, F. A. Trophic models and short-term simulations for the coral reefs of Cayos Cochinos and Media Luna (Honduras): a comparative network analysis, ecosystem development, resilience, and fishery. **Hydrobiologia**, v. 770, n. 1, p. 209–224, 2016.

CHAPMAN, D. G.; ROBSON, D. S. The analysis of a catch curve. **Biometrics**, v. 13, p. 354–368, 1960.

CHEA, R.; GUO, C.; GRENOUILLET, G.; LEK, S. Toward an ecological understanding

LIRA, A. S. Aplicação de modelos tróficos em um estuário de Pernambuco: Um estudo de caso em Sir

of a flood-pulse system lake in a tropical ecosystem: Food web structure and ecosystem health. **Ecological Modelling**, v. 323, p. 1–11, 2016.

CHEN, Z.; XU, S.; QIU, Y. Using a food-web model to assess the trophic structure and energy flows in Daya Bay, China. **Continental Shelf Research**, v. 111, p. 316–326, 2015.

CHRISTENSEN, V. Ecosystem maturity - towards quantification. **Ecological Modelling**, v. 77, n. 1, p. 3–32, 1995.

CHRISTENSEN, V.; PAULY, D. Trophic models of aquatic ecosystem. [s.l.] International Center for Living Aquatic Resources Management - ICLARM, 1993.

CHRISTENSEN, V.; WALTERS, C. J. Ecopath with Ecosim: Methods, capabilities and limitations. **Ecological Modelling**, v. 172, n. 2–4, p. 109–139, 2004.

CHRISTENSEN, V.; WALTERS, C. J.; PAULY, D. Ecopath with Ecosim: a user's guide. **Fisheries Centre Research Reports**, n. November, p. 154, 2005.

CHRISTENSEN, V.; WALTERS, C. J.; PAULY, D.; FORREST, R. Ecopath with Ecosim version 6 User Guide. **Fisheries Centre, University of British Columbia, Vancouver, Canada**, v. 281, n. November, p. 1–235, 2008.

CLOERN, J. E.; FOSTER, S. Q.; KLECKNER, A. E. Phytoplankton primary production in the world's estuarine-coastal ecosystems. **Biogeosciences**, v. 11, n. 9, p. 2477–2501, 2014.

CLOERN, J. E.; JASSBY, A. D. Drivers of change in estuarine - coastal ecosystems: discoveries from four decades of study in San Francisco Bay. **Reviews in Geophysics**, v. 50, p. 1–33, 2012.

COLL, M.; LIBRALATO, S.; TUDELA, S.; PALOMERA, I.; PRANOVI, F. Ecosystem overfishing in the ocean. **PLoS ONE**, v. 3, n. 12, 2008.

COLL, M.; PALOMERA, I.; TUDELA, S. Decadal changes in a NW Mediterranean Sea food web in relation to fishing exploitation. **Ecological Modelling**, v. 220, n. 17, p. 2088–2102, 2009.

COLL, M.; PALOMERA, I.; TUDELA, S.; SARDÀ, F. Trophic flows, ecosystem structure and fishing impacts in the South Catalan Sea, Northwestern Mediterranean. **Journal of Marine Systems**, v. 59, n. 1–2, p. 63–96, 2006a.

COLL, M.; SHANNON, L. J.; MOLONEY, C. L.; PALOMERA, I.; TUDELA, S. Comparing trophic flows and fishing impacts of a NW Mediterranean ecosystem with coastal upwelling systems by means of standardized models and indicators. **Ecological Modelling**, v. 198, n. 1–2, p. 53–70, 2006b.

COLLÉTER, M.; GASCUEL, D.; ECOUTIN, J. M.; TITO DE MORAIS, L. Modelling trophic flows in ecosystems to assess the efficiency of marine protected area (MPA), a case study on the coast of Sénégal. **Ecological Modelling**, v. 232, p. 1–13, 2012.

COLLETER, M.; VALLS, A.; GUITTON, J.; GASCUEL, D.; PAULY, D.; CHRISTENSEN, V. Global overview of the applications of the Ecopath with Ecosim modeling approach using the EcoBase models repository. **Ecological Modelling**, v. 302, p. 42–53, 2015.

CORRALES, X.; COLL, M.; TECCHIO, S.; BELLIDO, J. M.; FERNÁNDEZ, Á. M.; PALOMERA, I. Ecosystem structure and fishing impacts in the northwestern Mediterranean Sea using a food web model within a comparative approach. **Journal of Marine Systems**, v. 148, p. 183–199, 2015.

CORRALES, X.; OFIR, E.; COLL, M.; GOREND, M.; EDELIST, D.; HEYMANS, J.J.; GAL, G. Modeling the role and impact of alien species and fisheries on the Israeli marine continental shelf ecosystem. *Journal of Marine Systems* 170, p. 88–102, 2017.

COSTANZA, R.; DE GROOT, R.; SUTTON, P.; VAN DER PLOEG, S.; ANDERSON, S. J.; KUBISZEWSKI, I.; FARBER, S.; TURNER, R. K. Changes in the global value of ecosystem services. **Global Environmental Change**, v. 26, n. 1, p. 152–158, 2014.

COUILLARD, C. M.; OUELLET, P.; VERREAULT, G.; SENNEVILLE, S.; ST-ONGE-DROUIN, S.; LEFAIVRE, D. Effect of Decadal Changes in Freshwater Flows and Temperature on the Larvae of two Forage Fish Species in Coastal Nurseries of the St. Lawrence Estuary. **Estuaries and Coasts**, v. 40, n. 1, p. 268–285, 2017.

DARWALL, W. R. T.; ALLISON, E. H.; TURNER, G. F.; IRVINE, K. Lake of flies, or

LIRA, A. S. Aplicação de modelos tróficos em um estuário de Pernambuco: Um estudo de caso em Sir

lake of fish? A trophic model of Lake Malawi. **Ecological Modelling**, v. 221, n. 4, p. 713–727, 2010.

DE MUTSERT, K.; COWAN, J. H.; WALTERS, C. J. Using Ecopath with Ecosim to Explore Nekton Community Response to Freshwater Diversion into a Louisiana Estuary. **Marine and Coastal Fisheries**, v. 4, n. 1, p. 104–116, 2012.

DINEEN, G.; ROBERTSON, A. L. Subtle top-down control of a freshwater meiofaunal assemblage by juvenile fish. **Freshwater Biology**, v. 55, n. 9, p. 1818–1830, 2010.

DU, X.; GARCÍA-BERTHOUS, E.; WANG, Q.; LIU, J.; ZHANG, T.; LI, Z. Analyzing the importance of top-down and bottom-up controls in food webs of Chinese lakes through structural equation modeling. **Aquatic Ecology**, v. 49, n. 2, p. 199–210, 2015.

ECOUTIN, J.-M.; SIMIER, M.; ALBARET, J.-J.; LAË, R.; RAFFRAY, J.; SADIO, O.; DE MORAIS, L. T. Ecological field experiment of short-term effects of fishing ban on fish assemblages in a tropical estuarine {MPA}. **Ocean & Coastal Management**, v. 100, p. 74–85, 2014.

ELFES, C. T.; LONGO, C.; HALPERN, B. S.; HARDY, D.; SCARBOROUGH, C.; BEST, B. D.; PINHEIRO, T.; DUTRA, G. F. A regional-scale ocean health index for Brazil. **PLoS ONE**, v. 9, n. 4, 2014.

ELLIOTT, M.; WHITFIELD, A. K.; POTTER, I. C.; BLABER, S. J. M.; CYRUS, D. P.; NORDLIE, F. G.; HARRISON, T. D. The guild approach to categorizing estuarine fish assemblages: A global review. **Fish and Fisheries**, v. 8, n. 3, p. 241–268, 2007.

ESSINGTON, T. E.; BEAUDREAU, A. H.; WIEDENMANN, J. Fishing through marine food webs. **Proceedings of the National Academy of Sciences of the United States of America**, v. 103, n. November, p. 3171–3175, 2006.

FABIO, P.; SILVIA, C.; PAOLO, V.; ANELLI MONTI, M. Present and future status of artisanal fisheries in the Adriatic Sea (western Mediterranean Sea). **Ocean & Coastal Management**, v. 122, n. 1967, p. 49–56, 2016.

FINN, J. T. Measures of ecosystem structure and function derived from analysis of flows. **Journal of Theoretical Biology**, v. 56, n. 2, p. 363–380, 1976.

LIRA, A. S. Aplicação de modelos tróficos em um estuário de Pernambuco: Um estudo de caso em Sir

FREIRE, K. M. F.; CHRISTENSEN, V.; PAULY, D.; FREIRE, K. M. F.; CHRISTENSEN, V.; PAULY, D. Description of the East Brazil Large Marine Ecosystem using a trophic model The columns of Table 2 in. **Scientia Marina**, v. 72, n. 3, p. 477–491, 2008.

FROESE, R.; BINOHLAN, C. Empirical relationships to estimate asymptotic length, length at first maturity and length at maximum yield per recruit in fishes, with a simple method to evaluate length frequency data. **Journal of Fish Biology**, v. 56, n. 4, p. 758–773, 2000.

GARCIA, S. .; ZERBI, A.; ALIAUME, C.; DO CHI, T.; LASSERRE, G. The ecosystem approach to fisheries. **FAO Fisheries Technical Paper**, v. 443, p. 71, 2003.

GARDNER, M. R.; ASHBY, W. R. **Connectance of large dynamic (cybernetic) systems: critical values for stability.** *Nature*, 1970. .

GERHARDINGER, L. C.; GODOY, E. A. S.; JONES, P. J. S. Local ecological knowledge and the management of marine protected areas in Brazil. **Ocean and Coastal Management**, v. 52, p. 154–165, 2009.

GOLDSWORTHY, S. D.; PAGE, B.; ROGERS, P. J.; BULMAN, C.; WIEBKIN, A.; MCLEAY, L. J.; EINODER, L.; BAYLIS, A. M. M.; BRALEY, M.; CAINES, R.; DALY, K.; HUVENEERS, C.; PETERS, K.; LOWTHER, A. D.; WARD, T. M. Trophodynamics of the eastern Great Australian Bight ecosystem: Ecological change associated with the growth of Australia’s largest fishery. **Ecological Modelling**, v. 255, p. 38–57, 2013.

GUBIANI, éder A.; ANGELINI, R.; VIEIRA, L. C. G.; GOMES, L. C.; AGOSTINHO, A. A. Trophic models in Neotropical reservoirs: Testing hypotheses on the relationship between aging and maturity. **Ecological Modelling**, v. 222, n. 23–24, p. 3838–3848, 2011.

GUENETTE, S. User’s guide to the “Ecopath with Ecosim ” model of the Bay of Bengal Large Marine. In: St. Andrews NB, Canada. **Anais...** St. Andrews NB, Canada: Bay of Bengal Large Marine Ecosystem Project, 2014.

GUO, C.; YE, S.; LEK, S.; LIU, J.; ZHANG, T.; YUAN, J.; LI, Z. The need for improved



fishery management in a shallow macrophytic lake in the Yangtze River basin: Evidence from the food web structure and ecosystem analysis. **Ecological Modelling**, v. 267, p. 138–147, 2013.

HALOUANI, G.; ABDOU, K.; HATTAB, T.; ROMDHANE, M. S.; BEN RAIS LASRAM, F.; LE LOC'H, F. A spatio-temporal ecosystem model to simulate fishing management plans: A case of study in the Gulf of Gabes (Tunisia). **Marine Policy**, v. 69, p. 62–72, 2016a.

HALOUANI, G.; BEN RAIS LASRAM, F.; SHIN, Y. J.; VELEZ, L.; VERLEY, P.; HATTAB, T.; OLIVEROS-RAMOS, R.; DIAZ, F.; M?NARD, F.; BAKLOUTI, M.; GUYENNON, A.; ROMDHANE, M. S.; LE LOC'H, F. Modelling food web structure using an end-to-end approach in the coastal ecosystem of the Gulf of Gabes (Tunisia). **Ecological Modelling**, v. 339, p. 45–57, 2016b.

HALPERN, B. S.; LONGO, C.; HARDY, D.; MCLEOD, K. L.; SAMHOURI, J. F.; KATONA, S. K.; KLEISNER, K.; LESTER, S. E.; O'LEARY, J.; RANELLETTI, M.; ROSENBERG, A. A.; SCARBOROUGH, C.; SELIG, E. R.; BEST, B. D.; BRUMBAUGH, D. R.; CHAPIN, F. S.; CROWDER, L. B.; DALY, K. L.; DONEY, S. C.; ELFES, C.; FOGARTY, M. J.; GAINES, S. D.; JACOBSEN, K. I.; KARRER, L. B.; LESLIE, H. M.; NEELEY, E.; PAULY, D.; POLASKY, S.; RIS, B.; ST MARTIN, K.; STONE, G. S.; SUMAILA, U. R.; ZELLER, D. An index to assess the health and benefits of the global ocean. **Nature**, v. 488, n. 7413, p. 615–620, 2012.

HAN, R.; CHEN, Q.; WANG, L.; TANG, X. Preliminary investigation on the changes in trophic structure and energy flow in the Yangtze estuary and adjacent coastal ecosystem due to the Three Gorges Reservoir. **Ecological Informatics**, 2016.

HEYMANS, J.; BAIRD, D. Network analysis of the northern Benguela ecosystem by means of network and ecopath. **Ecological Modelling**, v. 131, n. 2–3, p. 97–119, 2000.

HEYMANS, J.J. Ecosystem models of Newfoundland and Southeastern Labrador: additional information and analyses for 'Back to the Future'. *Fish Cent Res Rep* 11(5):1–81, 2003.

HEYMANS, J. J.; COLL, M.; LIBRALATO, S.; MORISSETTE, L.; CHRISTENSEN, V. Global patterns in ecological indicators of marine food webs: A modelling approach.

**PLoS ONE**, v. 9, n. 4, 2014.

HEYMANS, J. J.; COLL, M.; LINK, J. S.; MACKINSON, S.; STEENBEEK, J.; WALTERS, C.; CHRISTENSEN, V. Best practice in Ecopath with Ecosim food-web models for ecosystem-based management. **Ecological Modelling**, v. 331, p. 173–184, 2016.

HEYMANS, J. J.; SHANNON, L. J.; JARRE, A. Changes in the northern Benguela ecosystem over three decades: 1970s, 1980s, and 1990s. **Ecological Modelling**, v. 172, n. 2–4, p. 175–195, 2004.

HOOPER, D. U.; CHAPIN III, F. S.; EWEL, J. J.; HECTOR, A.; INCHAUSTI, P.; LAVOREL, S.; HAWTON, J. H.; LODGE, D. M.; LOREAU, M.; NAEEM, S.; SCHMID, B.; SETÄLÄ, H.; SYMSTAD, A. J.; VANDERMEER, J.; WARDLE, D. A. Effects of biodiversity on ecosystem functioning: a consensus of current knowledge. **Ecological Monographs**, v. 75, n. July 2004, p. 3–35, 2005.

HORNBORG, S.; BELGRANO, A.; BARTOLINO, V.; VALENTINSSON, D.; ZIEGLER, F. Trophic indicators in fisheries: a call for re-evaluation. **Biology letters**, v. 9, n. 1, p. 20121050, 2013.

HYNDES, G. A.; NAGELKERKEN, I.; MCLEOD, R. J.; CONNOLLY, R. M.; LAVERY, P. S.; VANDERKLIFT, M. A. Mechanisms and ecological role of carbon transfer within coastal seascapes. **Biological Reviews**, v. 89, n. 1, p. 232–254, 2014.

IBAMA. Estatística da pesca - 2006, grandes regiões e unidades da federação. [s.l.: s.n.]

KALTENBERG, A. M.; BENOIT-BIRD, K. J. Balanced harvest: utopia, failure, or a functional strategy? **ICES Journal of Marine Science**, v. 73, n. 6, p. 1616–1622, 2016.

KEMPTON, R. A.; TAYLOR, L. R. Models and statistics for species diversity. **Nature**, v. 262, n. 5571, p. 818–820, 1976.

KLEISNER, K.; MANSOUR, H.; PAULY, D. Region-based MTI: Resolving geographic expansion in the Marine Trophic Index. **Marine Ecology Progress Series**, v. 512, p. 185–199, 2014.

KROETZ, A. M.; DRYMON, J. M.; POWERS, S. P. Comparative Dietary Diversity and

LIRA, A. S. Aplicação de modelos tróficos em um estuário de Pernambuco: Um estudo de caso em Sir

Trophic Ecology of Two Estuarine Mesopredators. **Estuaries and Coasts**, p. 1–12, 2016.

LAURETTA, M.; CAMP, E.; PINE, W.; FRAZER, T. Catchability model selection for estimating the composition of fishes and invertebrates within dynamic aquatic ecosystems. **Canadian Journal of Fisheries and Aquatic Sciences**, v. 70, n. August 2015, p. 381–392, 2013.

LAYMAN, C. A.; QUATTROCHI, J. P.; PEYER, C. M.; ALLGEIER, J. E. Niche width collapse in a resilient top predator following ecosystem fragmentation. **Ecology Letters**, v. 10, n. 10, p. 937–944, 2007.

LE QUESNE, W. J. F.; JENNINGS, S. Predicting species vulnerability with minimal data to support rapid risk assessment of fishing impacts on biodiversity. **Journal of Applied Ecology**, v. 49, n. 1, p. 20–28, 2012.

LERCARI, D.; HORTA, S.; MARTÍNEZ, G.; CALLIARI, D.; BERGAMINO, L. A food web analysis of the Río de la Plata estuary and adjacent shelf ecosystem: trophic structure, biomass flows, and the role of fisheries. **Hydrobiologia**, p. 39–58, 2015.

LESSA, R. P.; MONTEIRO, A.; DUARTE-NETO, P. J.; VIEIRA, A. C. Multidimensional analysis of fishery production systems in the state of Pernambuco, Brazil. **Journal of Applied Ichthyology**, v. 25, n. 3, p. 256–268, 2009.

LIBRALATO, S.; CHRISTENSEN, V.; PAULY, D. A method for identifying keystone species in food web models. **Ecological Modelling**, v. 195, n. 3–4, p. 153–171, 2006.

LIBRALATO, S.; COLL, M.; TUDELA, S.; PALOMERA, I.; PRANOVI, F. Novel index for quantification of ecosystem effects of fishing as removal of secondary production. **Marine Ecology Progress Series**, v. 355, p. 107–129, 2008.

LINDEMAN, R. L. The Trophic-Dynamic Aspect of Ecology. **Ecology**, v. 23, n. 4, p. 399–417, 1942.

LYNAM, C. P.; MACKINSON, S. How will fisheries management measures contribute towards the attainment of Good Environmental Status for the North Sea ecosystem? **Global Ecology and Conservation**, v. 4, p. 160–175, 2015.

MAHONEY, P. C.; BISHOP, M. J. Assessing risk of estuarine ecosystem collapse.

**Ocean and Coastal Management**, v. 140, p. 46–58, 2017.

MAIA, L. P.; LACERDA, L. D. De; MONTEIRO, L. H. U.; SOUZA, G. M. Atlas dos manguezais do nordeste do Brasil. p. 55 pp., 2006.

MCQUAID, K. A.; GRIFFITHS, C. L. Alien reef-building polychaete drives long-term changes in invertebrate biomass and diversity in a small, urban estuary. **Estuarine, Coastal and Shelf Science**, v. 138, p. 101–106, 2014.

MEIRE, P.; YSEBAERT, T.; VAN DAMME, S.; VAN DEN BERGH, E.; MARIS, T.; STRUYF, E. The Scheldt estuary: A description of a changing ecosystem. **Hydrobiologia**, v. 540, n. 1–3, p. 1–11, 2005.

MELLO, M. V. L. de. Parâmetros hidrológicos correlacionados com a biomassa e composição fitoplantônica na região costeira adjacente a desembocadura do rio sirinhaém (pernambuco - brasil). 2009. Universidade Federal dePernambuco, 2009.

MERIGOT, B.; LUCENA FRÉDOU, FLÁVIA VIANA, A. P.; FERREIRA, B. P.; COSTA JUNIOR, E. do N.; SILVA-JÚNIOR, C. A. B. da; FRÉDOU, T. Fish assemblages in tropical estuaries of Northeast Brazil: a multi-component diversity approach. **Ocean & Coastal Management**, n. August, p. 1–9, 2016.

MORISSETTE, L.; HAMMILL, M. O.; SAVENKOFF, C. The Trophic Role of Marine Mammals in the Northern Gulf of St. Lawrence. **Marine Mammal Science**, v. 22, n. 1, p. 74–103, 2006.

MORMEDE, S.; DUNN, A.; PARKER, S.; HANCHET, S. Using spatial population models to investigate the potential effects of the Ross Sea region Marine Protected Area on the Antarctic toothfish population. **Fisheries Research**, v. 190, p. 164–174, 2017.

MORRIS, R. J.; SINCLAIR, F. H.; BURWELL, C. J. Food web structure changes with elevation but not rainforest stratum. **Ecography**, v. 38, n. 8, p. 792–802, 2015.

MOURÃO, K. R. M.; FERREIRA, V.; LUCENA-FRÉDOU, F. Composition of functional ecological guilds of the fish fauna of the internal sector of the amazon estuary, par??, Brazil. **Anais da Academia Brasileira de Ciencias**, v. 86, n. 4, p. 1783–1800, 2014.

LIRA, A. S. Aplicação de modelos tróficos em um estuário de Pernambuco: Um estudo de caso em Sir

NASCIMENTO, M. C.; VELASCO, G.; OKEY, T. a.; CHRISTENSEN, V.; Z. AMARAL, a. C. Trophic model of the outer continental shelf and upper slope demersal community of the southeastern Brazilian Bight. **Scientia Marina**, v. 0, n. 0, p. 763–779, 2011.

NICHOLS, F. H. Sediment turnover by a deposit-feeding polychaete. **Limnology and Oceanography**, v. 19, n. 6, p. 945–950, 1974.

NICOLODI, J.; ZAMBONI, A.; BARROSO, G. Gestão integrada de bacias hidrográficas e zonas costeiras no Brasil: implicações para a região hidrográfica Amazônica. **Revista da Gestão Costeira Integrada**, v. 9, n. 2, p. 9–32, 2009.

O'BRIEN, A.; TOWNSEND, K.; HALE, R.; SHARLEY, D.; PETTIGROVE, V. How is ecosystem health defined and measured? A critical review of freshwater and estuarine studies. **Ecological Indicators**, v. 69, p. 722–729, 2016.

ODUM, E. P. The Strategy of Ecosystem Development. **Science**, v. 164, n. 3877, p. 262–270, 1969.

ODUM, E. P. Fundamentals of ecology. Philadelphia: Saunders, 1971.

ODUM, E. P.; BARRET, G. W. Fundamentos de ecologia. 5. ed. São Paulo: Thomson Learning, 2007.

OLIVEROS-RAMOS, R.; VERLEY, P.; ECHEVIN, V.; YUNNE-JAI, S. A sequential approach to calibrate ecosystem models with multiple time series data. **Progress in Oceanography**, v. 151, p. 227–244, 2017.

PAIVA, A. C. G.; ARAÚJO, M. E. Environmental characterization and spatial distribution of fish fauna in estuaries in the state of Pernambuco, Brazil. **Tropical Oceanography Online**, v. 38, n. 1, p. 1–46, 2010.

PALLERO FLORES, C.; BARRAGAN MUÑOZ, J. M.; SCHERER, M. E. G. Management of transboundary estuaries in Latin America and the Caribbean. **Marine Policy**, v. 76, n. September 2016, p. 63–70, 2017.

PALOMARES, M. L. D.; PAULY, D. Predicting food consumption of fish populations as functions of mortality, food type, morphometrics, temperature and salinity. **Marine**

**and Freshwater Research**, v. 49, n. 5, p. 447, 1998.

PASQUAUD, S.; PILLET, M.; DAVID, V.; SAUTOUR, B.; ELIE, P. Determination of fish trophic levels in an estuarine system. **Estuarine, Coastal and Shelf Science**, v. 86, n. 2, p. 237–246, 2010.

PATRÍCIO, J.; MARQUES, J.C. Mass balanced models of the food web in three areas along a gradient of eutrophication symptoms in the south arm of the Mondego estuary (Portugal). **Ecological modelling**, 197, pp 21–34, 2006.

PAULY, D. On the Interrelationships between Natural Mortality, Growth Parameters, and Mean Environmental Temperature in 175 Fish Stocks. **Journal du Conseil**, v. 39, n. 2, p. 175–192, 1980.

PAULY, D. Algunos métodos simples para la evaluación de recursos pesqueros tropicales. [s.l: s.n.]v. 234

PAULY, D.; CHRISTENSEN, V. Primary production required to sustain global fisheries. **Nature**, v. 374, n. 6519, p. 255–257, 1995.

PAULY, D.; PALOMARES, M. L. D.; SORIANO-BARTZ, M. Improved construction, parameterisation and interpretation of steady-state ecosystem models. In: VILLY, C.; PAULY, D. (Ed.). **Trophic models of aquatic ecosystems**. [s.l.] International Center for Living Aquatic Resources Management - ICLARM, 1993. p. 403.

PEREIRA, H. M.; NAVARRO, L. M.; MARTINS, I. S. Global biodiversity change: the bad, the good, and the unknown. **Annual Review of Environment and Resources**, v. 37, n. 1, p. 25–50, 2012.

PEREIRA, T. J.; MANIQUE, J.; QUINTELLA, B. R.; CASTRO, N.; DE ALMEIDA, P. R.; COSTA, J. L. Changes in trophic ecology of fish assemblages after no take Marine Protected Area designation in the southwestern coast of Portugal. **Ocean & Coastal Management**, v. 137, p. 144–153, 2017.

PIKITCH, E. K.; SANTORA, C.; BABCOCK, E. A.; BAKUN, A.; BONFIL, R.; CONOVER, D. O.; DAYTON, P.; DOUKAKIS, P.; FLUHARTY, D.; HENEMAN, B.; HOUDE, E. D.; LINK, J.; LIVINGSTON, P. A.; MANGEL, M.; MCALLISTER, M. K.;

LIRA, A. S. Aplicação de modelos tróficos em um estuário de Pernambuco: Um estudo de caso em Sir

POPE, J.; SAINSBURY, K. J. Ecosystem-Based Fishery Management. **Science**, v. 305, n. 5682, p. 346–347, 2004.

PLAGÁNYI, E. E. Models for an ecosystem approach to fisheries. [s.l: s.n.]v. 477

PREMCHAROEN, S.; PATHOM, N. Feeding Patterns Of Resident Fishes In Thai Mangrove Estuary: Implications For Conservation And Sustainable Use Of Coastal Resources. **European Journal of Sustainable Development**, v. 3, n. 3, p. 201–210, 2014.

ROMAGNONI, G.; MACKINSON, S.; HONG, J.; MARIA, A. The Ecospace model applied to the North Sea : Evaluating spatial predictions with fish biomass and fishing effort data. **Ecological Modelling**, v. 300, p. 50–60, 2015.

ROSA, R.; CARVALHO, A. R.; ANGELINI, R. Integrating fishermen knowledge and scientific analysis to assess changes in fish diversity and food web structure. **Ocean and Coastal Management**, v. 102, n. PA, p. 258–268, 2014.

ROSENBERG, R. Marine benthic faunal successional stages and related sedimentary activity. **Scientia Marina**, v. 65, p. 107–119, 2001.

RUIZ, D. J.; BANKS, S.; WOLFF, M. Elucidating fishing effects in a large-predator dominated system: The case of Darwin and Wolf Islands (Galápagos). **Journal of Sea Research**, v. 107, p. 1–11, 2016.

SCHARLER, U. M.; BAIRD, D. A comparison of selected ecosystem attributes of three South African estuaries with different freshwater inflow regimes, using network analysis. **Journal of Marine Systems**, v. 56, n. 3–4, p. 283–308, 2005.

SHEAVES, M. Consequences of ecological connectivity: The coastal ecosystem mosaic. **Marine Ecology Progress Series**, v. 391, p. 107–115, 2009.

SHEAVES, M.; DINGLE, L.; MATTONE, C. Biotic hotspots in mangrove-dominated estuaries: macro-invertebrate aggregation in unvegetated lower intertidal flats . **Marine Ecology Progress Series**, v. 556, p. 31–43, 2016.

SILVA-JÚNIOR, C. A. B.; MÉRIGOT, B.; LUCENA-FRÉDOU, F.; FERREIRA, B. P.; COXEY, M. S.; REZENDE, S. M.; FRÉDOU, T. Functional diversity of fish in tropical

LIRA, A. S. Aplicação de modelos tróficos em um estuário de Pernambuco: Um estudo de caso em Sir

estuaries: A traits-based approach of communities in Pernambuco, Brazil. **Estuarine, Coastal and Shelf Science**, n. August, 2016.

SILVA, J. B. Da; GALVÍNCIO, J. D.; CORRÊA, A. C. D. B.; SILVA, D. G. Da; MACHADO, C. C. C. Classificação Geomorfológica dos Estuários do Estado de Pernambuco (Brasil) com Base em Imagens do LANDSAT 5/TM. **Revista Brasileira de Geografia Física**, v. 4, n. 1, p. 118–133, 2011.

SILVA, M. H. da. Estrutura e produtividade da comunidade fitoplantônica de um estuário tropical (Sirinhaém, Pernambuco, Brasil). p. 170, 2009.

SIMON, L. N.; RAFFAELLI, D. A Trophic Model Of The Cameroon Estuary Mangrove With Simulations Of Mangrove Impacts. **International Journal Of Scientific & Technology Research**, v. 5, n. 8, 2016.

TECCHIO, S.; CHAALALI, A.; RAOUX, A.; TOUS RIUS, A.; LEQUESNE, J.; GIRARDIN, V.; LASSALLE, G.; CACHERA, M.; RIOU, P.; LOBRY, J.; DAUVIN, J. C.; NIQUIL, N. Evaluating ecosystem-level anthropogenic impacts in a stressed transitional environment: The case of the Seine estuary. **Ecological Indicators**, v. 61, p. 833–845, 2016.

TECCHIO, S.; RIUS, A. T.; DAUVIN, J.-C.; LOBRY, J.; LASSALLE, G.; MORIN, J.; BACQ, N.; CACHERA, M.; CHAALALI, A.; VILLANUEVA, M. C.; NIQUIL, N. The mosaic of habitats of the Seine estuary: Insights from food-web modelling and network analysis. **Ecological Modelling**, v. 312, p. 91–101, 2015.

TESTA, J. M.; KEMP, W. M.; HARRIS, L. A.; WOODLAND, R. J.; BOYNTON, W. R. Challenges and Directions for the Advancement of Estuarine Ecosystem Science. **Ecosystems**, p. 1–9, 2016.

TISCHER, M.; SANTOS, M. C. F. Composição E Diversidade Da Ictiofauna Acompanhante De Peneídeos No Litoral Sul. **Arquivos de Ciência do Mar**, v. 36, p. 105–118, 2003.

TOMCZAK, M. T.; HEYMANS, J. J.; YLETYINEN, J.; NIIRANEN, S.; OTTO, S. A.; BLECKNER, T. Ecological Network Indicators of Ecosystem Status and Change in the Baltic Sea. **PLoS ONE**, v. 8, n. 10, p. 1–11, 2013.



LIRA, A. S. Aplicação de modelos tróficos em um estuário de Pernambuco: Um estudo de caso em Sir

ULANOWICZ, R. E. Growth and development: ecosystems phenomenology. [s.l.] Lincoln, NE: toExcel Press, 1986.

ULANOWICZ, R.; PUCCIA, C. Mixed trophic impacts in ecosystems. **Coenoses**, v. 5, n. 1, p. 7–16, 1990.

VALLS, A.; COLL, M.; CHRISTENSEN, V.; ELLISON, A. M. Keystone species: toward an operational concept for marine biodiversity conservation. **Ecological Monographs**, v. 85, n. 1, p. 29–47, 2015.

VASCONCELLOS, M.; MACKINSON, S.; SLOMAN, K.; PAULY, D. The stability of trophic mass-balanced models of marine ecosystems: a comparative analysis. **Ecological modelling**, v. 100, p. 125–134, 1997.

VIANA, A. P.; FRÉDOU, F. L.; FRÉDOU, T. Measuring the ecological integrity of an industrial district in the Amazon estuary, Brazil. **Marine Pollution Bulletin**, v. 64, n. 3, p. 489–499, 2012.

VILLANUEVA, M. C. Contrasting tropical estuarine ecosystem functioning and stability: A comparative study. **Estuarine, Coastal and Shelf Science**, v. 155, p. 89–103, 2015.

VILLASANTE, S.; ARREGUÍN-SÁNCHEZ, F.; HEYMANS, J.J.; LIBRALATO, S.; PIRODDI, C.; CHRISTENSEN, V.; COLL, M. Modelling marine ecosystems using the Ecopath with Ecosim food web approach: New insights to address complex dynamics after 30 years of developments. **Ecological Modelling**, V.331, p.1–4. 2016.

WALTERS, C. J.; PAULY, D.; CHRISTENSEN, C. V. Structuring dynamic models of exploited ecosystems from trophic mass-balance assessments. **Reviews in Fish Biology and Fisheries**, v. 7, n. 2, p. 139–172, 1997.

WALTERS, C.; PAULY, D.; CHRISTENSEN, V.; KITCHELL, J. F. Representing density dependent consequences of life history strategies in aquatic ecosystems: EcoSim II. **Ecosystems**, v. 3, n. 1, p. 70–83, 2000.

WANG, Y.; HU, J.; PAN, H.; LI, S.; FAILLER, P. An integrated model for marine fishery management in the Pearl River Estuary: Linking socio-economic systems and

LIRA, A. S. Aplicação de modelos tróficos em um estuário de Pernambuco: Um estudo de caso em Sir

ecosystems. **Marine Policy**, v. 64, p. 135–147, 2016.

WANG, Y.; LI, S. Y.; DUAN, L. J.; LIU, Y. Fishery policy exploration in the Pearl River Estuary based on an Ecosim model. **Ecological Modelling**, v. 230, p. 34–43, 2012.

WASSERMAN, R. J.; NOYON, M.; AVERY, T. S.; FRONEMAN, P. W. Trophic Level Stability-Inducing Effects of Predaceous Early Juvenile Fish in an Estuarine Mesocosm Study. **PLoS ONE**, v. 8, n. 4, 2013.

WOLFF, M.; KOCH, V.; ISAAC, V. A Trophic Flow Model of the Caeté Mangrove Estuary (North Brazil) with Considerations for the Sustainable Use of its Resources. **Estuarine, Coastal and Shelf Science**, v. 50, n. 6, p. 789–803, 2000.

XAVIER, H. J. D. A. Teia trófica e fluxo de energia no estuário do rio mamanguape, paraíba, brasil. 2013. Universidade Federal da Paraíba, 2013.

XIA, Y.; TABETA, S. Fundamental study on ecosystem in East China Sea by an integrated model of low and high trophic levels. In: **OCEANS 2016 - Shanghai**. Shanghai: OCEANS 2016 - Shanghai, 2016. p. 1–5.

### **3. Considerações Finais**

O Modelo Ecopath do Estuário do Rio Sirinhaém é considerado o primeiro modelo ecossistema estuarina no estado de Pernambuco, se tornando um ponto de partida para outros estudos de estrutura trófica com foco na gestão do ecossistema da região, tendo como base o nosso modelo. O ecossistema Sirinhaém, mostrou uma estrutura trófica semelhante a outros sistemas estuarino tropicais, com uma grande contribuição para a rede trófica vinda do Fitoplâncton. O camurim mostrou-se um componente muito importante no ecossistema, demonstrando ter um efeito forte sobre os outros componentes. Este efeito está associado aos impactos provenientes da predação causando o conhecido efeito cascata “Top-Down”. Mesmo considerando que o SRE tem alto impacto principalmente pela cana-de-açúcar e outras indústrias de agronegócio, os índices de maturidade do ecossistema indicaram que o sistema estuarino de Sirinhaém está em desenvolvimento, estável e tem boa capacidade de resistência a perturbações externas, mas necessitando de proteção, pois mesmo estando localizado entre duas áreas marinhas protegidas, ambas não apresentam nenhum plano de manejo. A carência de informações biológicas básicas para região de Sirinhaém foram os principais entraves encontrada para elaboração do modelo, reforçando a necessidade de estudos de base para estruturação do modelo. Entretanto, os critérios de avaliação do modelo foram satisfatórios indicando que o mesmo foi bem-sucedido em sua aplicação. Por fim, estudos futuros são necessários, principalmente aqueles que ajudem a compreender o efeito da pesca no ecossistema de Sirinhaém com maior precisão.

#### 4. Anexos

SOM 1: Biomass (t.km<sup>-2</sup>) of fish before and after the application of the catchability model (based on Lauretta et al., 2013).  $qL$  is the selected catchability coefficient for each species based in morphology of the caudal fin.  $p$  is the mean proportion of the population captured by the fishing gear  $p = (qL * E) / A$ , where  $E$  is effort (total area dragged),  $A$  is habitat area.

	B (t.km <sup>-2</sup> ) Before	$qL$	$p$	B (t.km <sup>-2</sup> ) After	Caudal fin form	Similar group in catchability model
Herring	0.01216	0.814	0.037	0.3244	A	<i>Menidia beryllina</i> <sup>1</sup>
Anchovies	0.00084	0.814	0.037	0.022	A	<i>Menidia beryllina</i> <sup>1</sup>
Flatfish	0.02268	0.540	0.025	0.91222	B	<i>Trinectes maculatus</i> <sup>2</sup>
Puffer	0.03144	0.784	0.036	0.8709	C	<i>Fundulus</i> spp. <sup>3</sup>
<i>Eucinostomus</i> spp.	0.00089	0.688	0.031	0.02821	D	<i>Eucinostomus harengulus</i> <sup>4</sup>
<i>Diapterus</i> spp.	0.05106	0.688	0.031	1.61209	D	<i>Eucinostomus harengulus</i> <sup>4</sup>
Snapper	0.00197	0.582	0.027	0.07367	E	<i>Lagodon rhomboides</i> <sup>5</sup>
<i>Sciades herzbergii</i>	0.14318	0.688	0.031	4.5735	D	<i>Eucinostomus harengulus</i> <sup>4</sup>
Other Catfish	0.05698	0.688	0.031	1.79891	D	<i>Eucinostomus harengulus</i> <sup>4</sup>
Drum	0.00401	0.582	0.027	0.14974	D	<i>Lagodon rhomboides</i> <sup>5</sup>
Grunt	0.00277	0.582	0.027	0.1173	D	<i>Lagodon rhomboides</i> <sup>5</sup>
Croaker	0.01569	0.784	0.036	0.4346	C	<i>Fundulus</i> spp. <sup>3</sup>
Snook	0.08108	0.688	0.031	2.5598	D	<i>Eucinostomus harengulus</i> <sup>4</sup>
Jack	0.00716	0.688	0.031	0.22606	D	<i>Eucinostomus harengulus</i> <sup>4</sup>
Morphology of the caudal fin						
	A	B	C	D	E	

SOM 2: Parameters and references used for estimation of P/B.  $L_{max}$  is the maximum length captured of the species (cm);  $L_{\infty}$  is the asymptotic length (cm) and  $k$  is growth coefficient. \*  $L_{\infty}$  and  $k$  were estimated and based on empirical relationships;  $\log L_{\infty} = 0.044 + 0.9841 * \log(L_{max})$  (Froese and Binohlan, 2000) and  $k = 2.15 * L_{\infty}^{-0.46}$  (Le Quesne and Jennings, 2012), respectively.

Group name	$L_{max}$ (cm)	$L_{\infty}$ (cm)	$k$	Reference
Herring	-	33.7	1.2	Lessa et al. (2008)
Anchovies*	-	15.67	1.05	Souza-Conceicao and Schwingel (2011)
Mullet	-	38.01	0.36	Santana et al. (2009)
Flatfish*	15.3	16.21	0.59	Viana et al. (2016)
Puffer	-	29.5	0.77	Tzeek-Tuz et al. (2012)
<i>Eucinostomus spp</i>	-	28.31	0.61	Silva et al. (2014)
<i>Diapterus spp*</i>	42.3	44.1	0.24	Elliff et al. (2013)
<i>Snapper</i>	-	77.22	0.11	Rezende and Ferreira (2004)
<i>Sciades herzbergii</i>	-	51.05	0.15	Araújo-Junior et al. (2006)
Others Catfish*	36.5	38.15	0.40	Viana et al. (2016)
Drum*	-	36.6	0.48	Louis (1985)
Grunt*	36.6	38.25	0.40	Cervigón et al. (1992)
Croaker	-	60	0.05	Santos (2015)
Snook	-	140.8	0.07	Mendonça (2004)
Jack*	124	127.1	0.23	Cervigón et al. (1992)

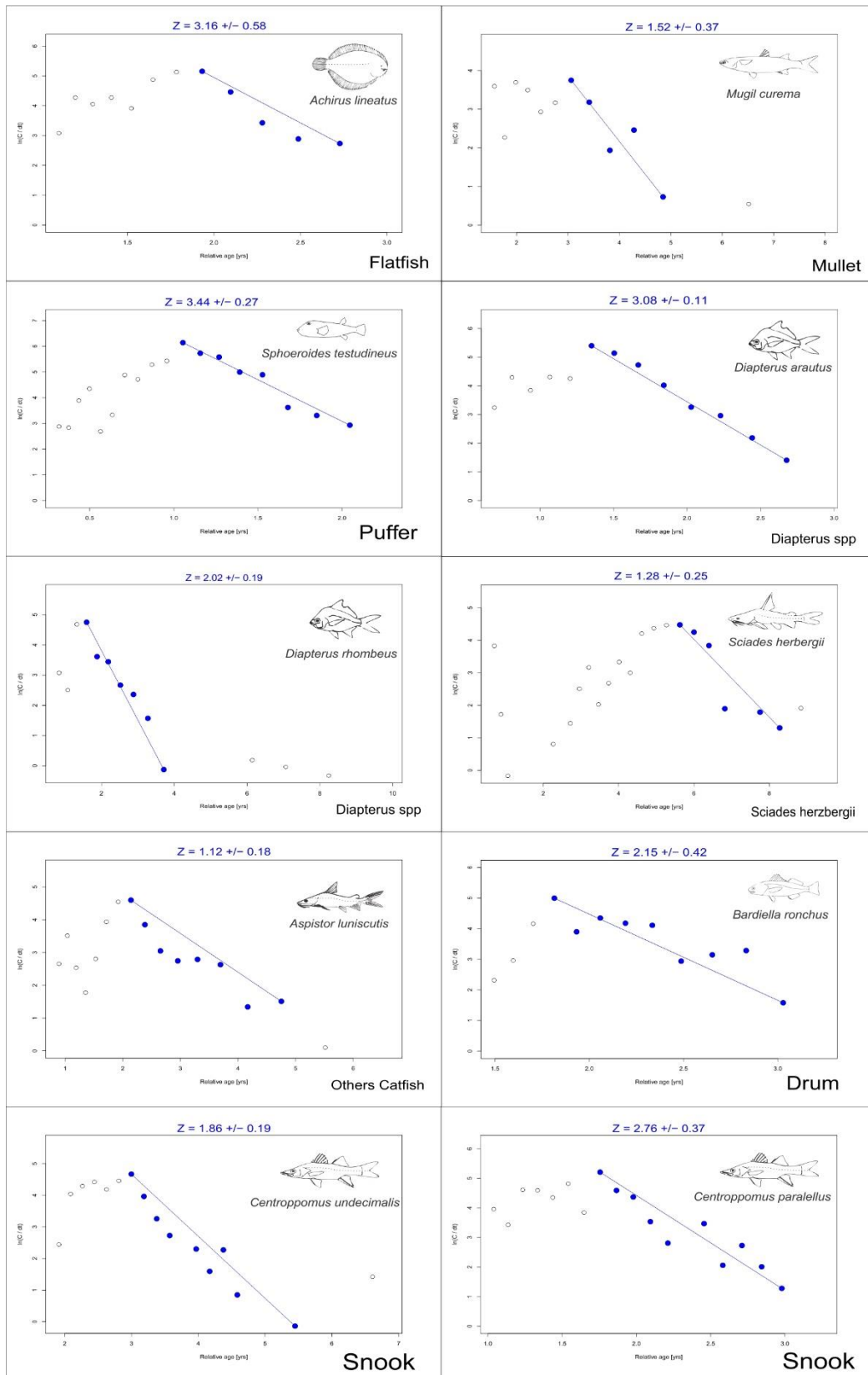

SOM 3: Linearized length converted catch curve to estimate the total mortality ( $Z \pm SE$ ) (CHAPMAN and ROBSON, 1960; PAULY, 1983) for the main compartments caught by local fishery. Source of data: Bioimpact database from 2011 – 2015.

SOM 4: Parameters used as input for the estimation of the annual food consumption/biomass ratio (Q/B) of fish group.  $W_{\infty}$  is the asymptotic weight, obtained from equation  $W_{\infty}=a \cdot L_{\infty}^b$ , where “a” is the regression intercept; “b” is the regression slope (see Viana et al., 2016); H and D represent the feeding type (h: 1 and d: 0 for herbivores; h: 0 and d: 1 for detritivores; h: 0 and d: 0 for carnivores); and Ar is aspect ratio of the caudal fin,  $Ar = h^2/s$ , where (h) is height of caudal fin and (s) is the surface area of the caudal fin, extending to the narrowest part of the caudal peduncle (based on Palomares and Pauly, 1998).

Group name	a	b	$W_{\infty}$ (g)*	H	D	h(mm)	s(mm <sup>2</sup> )	Ar**
Herring	0.0081	3.01	321.10	0	0	38.45	362.39	4.1
Anchovies	0.0036	3.30	31.62	1	0	15.06	73.06	3.56
Mullet	0.011	2.98	565.6	1	0	74.97	2030.53	2.77
Flatfish	0.0096	3.27	86.74	0	0	19.58	394.08	1.07
Puffer	0.0213	2.93	431.4	0	0	31.92	608.19	1.77
<i>Eucinostomus</i> spp.	0.008	3.15	299.64	0	0	24.47	327.25	2.16
<i>Diapterus</i> spp.	0.009	3.16	1413.9	0	0	38.75	543.80	2.82
<i>Snapper</i>	0.0156	3	7183.1	0	0	34.71	641.08	1.93
<i>Sciades herzbergii</i>	0.0059	3.11	1209.8	0	0	51.46	1151.53	2.31
Others Catfish	0.004	3.26	572.4	0	0	46.43	838.93	2.71
Drum	0.005	3.33	804.2	0	0	36.47	842.67	1.6
Grunt	0.0096	3.14	894.81	0	0	22.54	378.86	1.34
Croaker	0.0144	3.02	3375.8	0	0	48.04	1611.08	1.5
Snook	0.0083	2.91	14842.6	0	0	57.44	1606.55	2.08
Jack	0.0126	2.97	22370.8	0	0	46.02	669.58	3.33

SOM 5: Input data and references by compartment for the the Estuary of Sirinhaém River, Northeastern Brazil. B: biomass; P/B: production per unit of biomass;

Q/B: consumption rate per unit of biomass; EE: ecotrophic efficiency.

Group name	Original value	Reference	Observations
1	Phytoplankton		
	B	9.44 mg.Chl a.m <sup>-3</sup> (2.22 t. Km <sup>-2</sup> )	Silva (2009) Conversion of Chl a units for Wet weight (KASPRZAK et al., 2008)
	P/B	19.48 mgC.m <sup>-3</sup> .h <sup>-1</sup> (652.71 year <sup>-1</sup> )	Silva (2009) Conversion of C units for Wet weight (PAULY and CHRISTENSEN, 1995) Considered depth of euphotic zone equal to 0.85 m and 12 hours light per day
	EE	Estimation from ecopath	
2	Zooplankton		
	B	Estimation from ecopath	
	P/B	50.21 year <sup>-1</sup>	Albouy et al (2010); Angelini and Vaz-Velho (2011); Chea et al (2016); Chen et al (2015); Villanueva (2015) Data corrected for differences of temperature with the Opitz equation (OPITZ, 1996)
	Q/B	150.65 year <sup>-1</sup>	Albouy et al (2010); Angelini and Vaz-Velho (2011); Chea et al (2016); Chen et al (2015); Villanueva (2015) Data corrected for differences of temperature with the Opitz equation (OPITZ, 1996)
	EE	0.9	Albouy et al (2010); Angelini and Vaz-Velho (2011); Chea et al (2016); Chen et al (2015); Villanueva (2015) Data corrected for differences of temperature with the Opitz equation (OPITZ, 1996)
	Diet	Kleppel et al (1996); Schnetzer and Steinberg (2002); Schwamborn (1997)	
3	Epiphyton		
	B	1.37 t. Km <sup>-2</sup>	Baltar (1996)
	P/B	153.31 year <sup>-1</sup>	Baltar (1996)
	EE	Estimation from ecopath	
4	Microphytobenthos		
	B	Estimation from ecopath	
	P/B	23.49 gC.m <sup>-2</sup> (209.61 year <sup>-1</sup> )	Spilmont et al (2009); Underwood and Kromkamp (1999) Conversion of C units for Wet weight (PAULY and CHRISTENSEN, 1995)



LIRA, A. S. Aplicação de modelos tróficos em um estuário de Pernambuco: Um estudo de caso em Sir

5	EE	0.50	Wolff et al (2000)	
	Fiddler crabs			
	B	16 t. Km <sup>-2</sup>	Estimates from our samples data	
	P/B	7.3 year <sup>-1</sup>	Brey (1999); Koch and Wolff (2002); Koch et al (2005)	Estimation of P/B from equation Brey (1999) based in maximum age by species Koch et al (2005) and maximum body mass of the samples data
	Q/B	31.89 year <sup>-1</sup>	Nichols (1974)	Estimation of Q/B from relationship Nichols (1974) based in our samples data
6	EE		Estimation from ecopath	
	Diet		Koch and Wolff (2002); Nordhaus (2004)	
	Polychaetes			
	B	2.87 t. Km <sup>-2</sup>	Estimates from our samples data	
	P/B	2.91 year <sup>-1</sup>	Brey (1999); Otegui et al (2012); Santos (1994); Souza and Borzone (2007)	Estimation of P/B from equation Brey (1999) based in maximum age by species Otegui et al (2012); Santo (1994); Souza and Borzone (2007) and maximum body mass of the samples data
	Q/B	17.26 year <sup>-1</sup>	Nichols (1974)	Estimation of Q/B from relationship Nichols (1974) based in our samples data
7	EE		Estimation from ecopath	
	Diet		Opitz (1996)	
	Bivalves			
	B	90 t. Km <sup>-2</sup>	Estimates from our samples data	
	P/B	2 year <sup>-1</sup>	Opitz (1996)	Data of P/B corrected for differences of temperature with the Opitz equation (OPITZ, 1996)
	Q/B	9 year <sup>-1</sup>	Opitz (1996)	Data of Q/B corrected for differences of temperature with the Opitz equation (OPITZ, 1996)
	EE		Estimation from ecopath	
	Diet		Resgalla and Piovezan (2009)	

LIRA, A. S. Aplicação de modelos tróficos em um estuário de Pernambuco: Um estudo de caso em Sir

8	Gastropods				
	B	17.6 t. Km <sup>-2</sup>	Estimates from our samples data		
	P/B	2.65 year <sup>-1</sup>	Absalao et al (2009); Brey (1999)	Estimation of P/B from equation Brey (1999) based in maximum age by species Absalao et al (2009) and maximum body mass of the samples data	
	Q/B	38.83 year <sup>-1</sup>	Nichols (1974)	Estimation of Q/B from relationship Nichols (1974) based in our samples data	
	EE		Estimation from ecopath		
	Diet		Blanco and Scatena (2007); Da Cunha Lana and Guiss (1991); Opitz (1996)		
9	Blue crab				
	B		Estimation from ecopath		
	P/B	2 year <sup>-1</sup>	Christensen et al (2009); Walters et al (2008)	Data of P/B corrected for differences of temperature with the Opitz equation (OPITZ, 1996)	
	Q/B	8 year <sup>-1</sup>	Christensen et al (2009); Walters et al (2008)	Data of Q/B corrected for differences of temperature with the Opitz equation (OPITZ, 1996)	
	EE	0.76	Wolff et al (2000)		
	Diet		Chalegre (2008); Oliveira et al (2006)		
10	Shrimp				
	B		Estimation from ecopath		
	P/B	2.81 year <sup>-1</sup>	Opitz (1996)	Data of P/B corrected for differences of temperature with the Opitz equation (OPITZ, 1996)	
	Q/B	26.9 year <sup>-1</sup>	Opitz (1996)	Data of Q/B corrected for differences of temperature with the Opitz equation (OPITZ, 1996)	
	EE	0.95	Albouy et al (2010); Du et al (2015); Zetina-Rejón et al (2015)		
	Diet		Branco et al (2001); Moriarty and Barclay (1981); Newell et al (1995)		

LIRA, A. S. Aplicação de modelos tróficos em um estuário de Pernambuco: Um estudo de caso em Sir

11	Herring				
	B	0.32 t. Km <sup>-2</sup>	Estimates from our samples data		
	P/B	1.96 year <sup>-1</sup>	*		
	Q/B	18.34 year <sup>-1</sup>	**		
	EE		Estimation from ecopath		
	Diet		Chaves and Vendel (2008)		
12	Anchovies				
	B	0.02 t. Km <sup>-2</sup>	Estimates from our samples data		
	P/B	2.23 year <sup>-1</sup>	*		
	Q/B	90.39 year <sup>-1</sup>	**		
	EE		Estimation from ecopath		
	Diet		Gay et al (2002); Krumme et al (2008); Sergipensel et al (1999)		
13	Mullet				
	B		Estimates from ecopath		
	P/B	1.88 year <sup>-1</sup>	Z=P/B from Allen (1971)		Estimation of Z from Linearized length converted catch curve (PAULY, 1983)
	Q/B	43.15 year <sup>-1</sup>	**		
	EE	0.35	Colléter et al (2012) and Simon and Raffaelli (2016)		
	Diet		Vasconcelos Filho et al (2009)		
14	Flatfish				
	B	0.91 t. Km <sup>-2</sup>	Estimates from our samples data		
	P/B	3.16 year <sup>-1</sup>	Z=P/B from Allen (1971)		Estimation of Z from Linearized length converted catch curve (PAULY, 1983)
	Q/B	13.43 year <sup>-1</sup>	**		
	EE		Estimation from ecopath		
	Diet		Duarte and Andreato (2003); Vasconcelos Filho et al (2010)		
15	Puffer				
	B	0.87 t. Km <sup>-2</sup>	Estimates from our samples data		
	P/B	3.17 year <sup>-1</sup>	Z=P/B from Allen (1971)		Estimation of Z from Linearized length converted catch curve (PAULY, 1983)

LIRA, A. S. Aplicação de modelos tróficos em um estuário de Pernambuco: Um estudo de caso em Sir

	Q/B	11.06 year <sup>-1</sup>	**	
	EE		Estimation from ecopath	
	Diet		Chi-Espínola and Vega-Cendejas (2013); Santos and Rodriguez (2011); Vasconcelos Filho et al (1998)	
16	<i>Eucinostomus spp</i>			
	B	0.03 t. Km <sup>-2</sup>	Estimates from our samples data	
	P/B	1.33 year <sup>-1</sup>	*	
	Q/B	12.84 year <sup>-1</sup>	**	
	EE		Estimation from ecopath	
	Diet		Denadai et al (2012); Ramos et al (2014); Vasconcelos Filho et al (2010); complementary study Bioimpact	
17	<i>Diapterus spp</i>			
	B	1.61 t. Km <sup>-2</sup>	Estimates from our samples data	
	P/B	2.9 years <sup>-1</sup>	Z=P/B from Allen (1971)	Estimation of Z from Linearized length converted catch curve (PAULY, 1983)
	Q/B	10.73 years <sup>-1</sup>	**	
	EE		Estimation from ecopath	
	Diet		Chaves and Otto (1998); Denadai et al (2012) Complementary study Bioimpact	
18	<i>Snapper</i>			
	B	0.07 t. Km <sup>-2</sup>	Estimates from our samples data	
	P/B	0.33 year <sup>-1</sup>	*	
	Q/B	6.42 year <sup>-1</sup>	**	
	EE		Estimation from ecopath	
	Diet		Monteiro et al (2009)	
19	<i>Sciades herzbergii</i>			
	B	4.57 t. Km <sup>-2</sup>	Estimates from our samples data	
	P/B	1.38 year <sup>-1</sup>	Z=P/B from Allen (1971)	Estimation of Z from Linearized length converted catch curve (PAULY, 1983)

LIRA, A. S. Aplicação de modelos tróficos em um estuário de Pernambuco: Um estudo de caso em Sir

	Q/B	9.94 year <sup>-1</sup>	**	
	EE		Estimation from ecopath	
	Diet		Giarrizzo and Saint-Paul (2008) and complementary study bioimpact	
20	Others Catfish			
	B	1.8 t. Km <sup>-2</sup>	Estimates from our samples data	
	P/B	1.13 year <sup>-1</sup>	Z=P/B from Allen (1971)	Estimation of Z from Linearized length converted catch curve (PAULY, 1983)
	Q/B	12.5 year <sup>-1</sup>	**	
	EE		Estimation from ecopath	
	Diet		Bomfim (2014)	
21	Drum			
	B	0.15 t. Km <sup>-2</sup>	Estimates from our samples data	
	P/B	1.73 year <sup>-1</sup>	Z=P/B from Allen (1971)	Estimation of Z from Linearized length converted catch curve (PAULY, 1983)
	Q/B	9.43 year <sup>-1</sup>	**	
	EE		Estimation from ecopath	
	Diet		Vendel and Chaves (1998); Complementary study Bioimpact	
22	Grunt			
	B	0.12 t. Km <sup>-2</sup>	Estimates from our samples data	
	P/B	0.93 year <sup>-1</sup>	*	
	Q/B	8.78 year <sup>-1</sup>	**	
	EE		Estimation from ecopath	
	Diet		Complementary study Bioimpact	
23	Croaker			
	B	0.43 t. Km <sup>-2</sup>	Estimates from our samples data	
	P/B	0.21 year <sup>-1</sup>	*	
	Q/B	6.90 year <sup>-1</sup>	**	
	EE		Estimation from ecopath	
	Diet		Bessa et al (2015); Freret and Vanderli (2003)	
24	Snook			

	B	2.57 t. Km <sup>-2</sup>	Estimates from our samples data	
	P/B	1.68 year <sup>-1</sup>	Z=P/B from Allen (1971)	Estimation of Z from Linearized length converted catch curve (PAULY, 1983)
	Q/B	5.70 year <sup>-1</sup>	**	
	EE		Estimation from ecopath	
	Diet		Complementary study Bioimpact	
25	Jack			
	B	0.23 t. Km <sup>-2</sup>	Estimates from our samples data	
	P/B	0.46 year <sup>-1</sup>	*	
	Q/B	6.66 year <sup>-1</sup>	**	
	EE		Estimation from ecopath	
	Diet		Silvano (2001)	
26	Detritus	2.76 year <sup>-1</sup>	Pauly et al (1993)	Estimation of biomass from equation Pauly et al. (1993) based on the production primary data

\* $M=PB = k^{0.65} \cdot L_{\infty}^{-0.279} \cdot T^{0.463}$  based on the empirical equation of Pauly (1980); \*\* $\log QB = 7.964 - 0.204 \cdot \log W_{\infty} - 1.965 \cdot T' + 0.083 \cdot Ar + 0.532 \cdot H + 0.398 \cdot D$ , based on the empirical relationship of Palomares and Pauly (1998)

Conversion: Chl *a*/Wet weight= 0,5% (KASPRZAK et al., 2008); gC to Wet weight= 1:9 (PAULY and CHRISTENSEN, 1995); Wet weight to kJ= 11:2.5 (MILLS, 1980) ; Dry weight to Wet weight= 1:5 (PARSONS et al., 1977)

SOM 6: Total, mean and biomass of artisanal fishery landings in the Estuary of Sirinhaém River, Northeastern Brazil, from 2000 to 2007 (t) for each compartments.

Groups	2000	2001	2002	2003	2004	2005	2006	2007	/Year	t/Km <sup>2</sup> /Year
Snook	4.9	4.9	8	10.35	6.48	5.47	7.17	7.52	6.85	0.7812 <sup>a</sup>
** <i>Sciades herzbergii</i>	7.5	8.6	12.4	10.18	7.67	11	16.34	15.95	11.21	1.0651 <sup>b</sup>
** <i>Other Catfish</i>										
<i>Diapterus</i> spp.	1.7	2	1.9	1.79	1.52	1.57	2.73	2.37	1.95	0.2961 <sup>c</sup>
Mullet	8.5	9.4	9.7	9.9	5.87	7.94	9.7	7.12	8.51	0.9714 <sup>d</sup>

Letters indicate the caught percent in estuary: a- 60%; b- 50%; c- 80%; d- 60%.

\*\* The total caught percent in estuary, 84% is *Sciades herzbergii* and 16% is *Others Catfish*.

SOM 7: Input data for two scenarios with 12 simulations that represent the increase and decrease of fishing mortality for all fishing target species in the Estuary of Sirinhaém River, Northeastern Brazil. Where: F is the fishing mortality rate; F0 = initial mortality/catch in ecopath model; Fx = F0 × f (where f is a multiplier); Catch (t\*Km<sup>-2</sup>\*Year<sup>-1</sup>).

		Mullets	<i>Diapterus</i> spp.	<i>S. herzbergii</i>	Other Catfish	Snook
Increase						
F0	Catch	0.971	0.296	0.897	0.168	0.781
	F0	0.479	0.184	0.196	0.094	0.304
F0x1.1	Catch	1.069	0.326	0.986	0.185	0.859
	F1	0.526	0.202	0.216	0.103	0.334
F0x1.2	Catch	1.166	0.355	1.076	0.202	0.937
	F2	0.574	0.220	0.235	0.112	0.364
F0x1.3	Catch	1.263	0.385	1.166	0.219	1.016
	F3	0.622	0.239	0.255	0.122	0.395
F0x1.4	Catch	1.360	0.415	1.255	0.236	1.094
	F4	0.670	0.257	0.275	0.131	0.425
F0x1.5	Catch	1.457	0.444	1.345	0.253	1.172
	F5	0.718	0.276	0.294	0.140	0.455
F0x2	Catch	1.943	0.592	1.794	0.337	1.562
	F6	0.957	0.367	0.392	0.187	0.607
Decrease						
F0x0.9	Catch	0.8743	0.2666	0.8071	0.1515	0.7031
	F7	0.4307	0.1654	0.1765	0.0842	0.2732
F0x0.8	Catch	0.7771	0.2370	0.7174	0.1347	0.6250
	F8	0.3828	0.1470	0.1569	0.0749	0.2428
F0x0.7	Catch	0.6800	0.2073	0.6277	0.1178	0.5469
	F9	0.3350	0.1286	0.1373	0.0655	0.2125
F0x0.6	Catch	0.5829	0.1777	0.5381	0.1010	0.4687
	F10	0.2871	0.1102	0.1176	0.0562	0.1821
F0x0.5	Catch	0.4857	0.1481	0.4484	0.0842	0.3906
	F11	0.2393	0.0919	0.0980	0.0468	0.1518
F0x0 (Nofishing)	Catch	0	0	0	0	0
	F12	0	0	0	0	0



## References

ABSALAO, R. S.; CARDOSO, R. S.; ALENCAR, A. S. DE. Population dynamics and secondary production of the snail *Neritina virginea* (Linnaeus, 1753) (Mollusca: Gastropoda:Neritidae) in an estuary in southern Brazil. **Animal Biology Journal**, v. 1, p. 1–15, 2009.

ALBOUY, C.; MOUILLOT, D.; ROCKLIN, D.; CULIOLI, J. M.; LE LOC'H, F. Simulation of the combined effects of artisanal and recreational fisheries on a mediterranean MPA ecosystem using a trophic model. **Marine Ecology Progress Series**, v. 412, p. 207–221, 2010.

ALLEN, K. R. Relation Between Production and Biomass. **Journal of the Fisheries Research Board of Canada**, v. 28, n. 10, p. 1573–1581, 1971. Disponível em: <<http://dx.doi.org/10.1139/f71-236>>.

ANGELINI, R.; VAZ-VELHO, F. Ecosystem structure and trophic analysis of Angolan fishery landings. **Scientia Marina**, v. 75, n. 2, p. 309–319, 2011.

ARAÚJO-JUNIOR, E. S.; CASTRO, A. C. L.; SILVA-JUNIOR, M. G. Dinâmica populacional do bagre-guribu (*Hexanemichthys herzbergii*) (Teleostei, Ariidae) do Estuário do rio Anil (Maranhão-Brasil). **Boletim do Laboratório de Hidrobiologia**, v. 19, p. 41–50, 2006.

BALTAR, S. L. S. M. . Produção das algas epifíticas em pneumatóforos de *avicennia schaueriana* (stapf & leechman) e *laguncularia racemosa* (gaertn), no canal de santa cruz, itamaracá – pernambuco (brasil). 1996. Universidade Federal Rural de Pernambuco, 1996.

BESSA, E.; FERNANDEZ, W. S.; LUVISARO, C.; TURRA, A. Feeding habits of whitemouth croaker *Micropogonias furnieri* (Perciformes: Sciaenidae) in Caraguatatuba Bay, southeastern Brazil. **Brazilian Journal of Oceanography**, v. 63, n. 2, p. 125–134, 2015.

BLANCO, J.; SCATENA, F. The spatial arrangement of *Neritina virginea* (Gastropoda: Neritidae) during upstream migration in a split-channel reach. **River research and**

**applications**, v. 23, n. 3, p. 235–245, 2007.

BOMFIM, A. Bioecologia da ictiofauna marinha descartada pelo arrasto camaroeiro em prais da bacia portigar, brasil. 2014. Universidade Federal do Rio Grande do Norte, 2014.

BRANCO, J. O.; JUNIOR, MORITZ, H. C. M. Alimentação natural do camarão sete-barbas, *Xiphopenaeus kroyeri* (Heller) Crustacea, Decapoda), na Armação do Itapocoroy, Penha, Santa Catarina. **Revista Brasileira de Zoologia**, v. 18, n. 1, p. 53–61, 2001.

BREY, T. Growth performance and mortality in aquatic macrobenthic invertebrates. **Advances in Marine Biology**, v. 35, n. January 1999, p. 153–223, 1999.

CERVIGÓN, F.; CIPRIANI, R.; FISCHER, W.; GARIBALDI, L.; HENDRICKX, M.; LEMUS, A.; MÁRQUEZ, R.; POUTIERS, J.; ROBAINA, G.; RODRIGUEZ, B. Fichas fao de identificación de especies para los fines de la pesca. guía de campo de las especies comerciales marinas y de aguas salobres de la costa septentrional de sur américa. FAO, Rome, Rome: Preparado con el financiamiento de la Comisión de Comunidades Europeas y de NORAD., 1992.

CHALEGRE, K. Q. T. Fauna bêntica do infralitoral e alimentação natural de callinectes danae smith, 1869 (crustacea,portunidae) nos estuários dos rios botafogo e carrapicho, pernambuco, brasil. 2008. Universidade Federal de Pernambuco, 2008.

CHAPMAN, D. G.; ROBSON, D. S. The analysis of a catch curve. **Biometrics**, v. 13, p. 354–368, 1960.

CHAVES, P. D. T. D. C.; OTTO, G. Aspectos biológicos de *Diapterus rhombeus* (Cuvier) (Teleostei, Gerreidae) na Baía de Guaratuba, Paraná, Brasil. **Revista Brasileira de Zoologia**, v. 15, n. 2, p. 289–295, 1998.

CHAVES, P. D. T.; VENDEL, A. L. comparativ ativa peixes entre Análise compar ativa da alimentação de peix es ( T eleostei ) entr e ambientes de mar isma e de manguezal n um estuár io do sul do Br asil ( Baía de Guar atuba , Par marisma num estuário Brasil Paraná ). **Revista Brasileira de Zoologia**, v. 25, n. 1, p. 10–15, 2008.

CHEA, R.; GUO, C.; GRENOUILLET, G.; LEK, S. Toward an ecological understanding of a flood-pulse system lake in a tropical ecosystem: Food web structure and ecosystem

health. **Ecological Modelling**, v. 323, p. 1–11, 2016.

CHEN, Z.; XU, S.; QIU, Y. Using a food-web model to assess the trophic structure and energy flows in Daya Bay, China. **Continental Shelf Research**, v. 111, p. 316–326, 2015.

CHI-ESPÍNOLA, A. A.; VEGA-CENDEJAS, M. E. Hábitos alimenticios de *Sphoeroides testudineus* (Perciformes: Tetraodontidae) en el sistema lagunar de Ría Lagartos, Yucatán, México. **Revista de Biología Tropical**, v. 61, n. 2, p. 849–858, 2013.

CHRISTENSEN, V.; BEATTIE, A.; BUCHANAN, C.; MA, H.; MARTELL, S. J. D.; LATOUR, R. J.; PREIKSHOT, D.; SIGRIST, M. B.; UPHOFF, J. H.; WALTERS, C. J.; ROBERT J. WOOD; TOWNSEND, H. Fisheries ecosystem model of the Chesapeake Bay: Methodology, parameterization, and model exploration. **NOAA Tech. Memo**, n. October, 2009.

COLLÉTER, M.; GASCUEL, D.; ECOUTIN, J. M.; TITO DE MORAIS, L. Modelling trophic flows in ecosystems to assess the efficiency of marine protected area (MPA), a case study on the coast of Sénégal. **Ecological Modelling**, v. 232, p. 1–13, 2012.

DA CUNHA LANA, P.; GUISS, C. Influence of *Spartina alterniflora* on structure and temporal variability of macrobenthic associations in a tidal flat of Paranagua Bay (southeastern Brazil). **Marine Ecology Progress Series**, v. 73, n. 2–3, p. 231–244, 1991.

DENADAI, M. R.; SANTOS, F. B.; BESSA, E.; FERNANDEZ, W. S.; PASCHOAL, C. C.; TURRA, A. Diets of *eucinostomus argenteus* (baird & girard, 1855) and *diapterus rhombeus* (cuvier, 1829) (perciformes: Gerreidae) in caraguatubá bay, southeastern Brazil. **Pan-American Journal of Aquatic Sciences**, v. 7, n. 3, p. 143–155, 2012.

DU, J.; CHEUNG, W. W. L.; ZHENG, X.; CHEN, B.; LIAO, J.; HU, W. Comparing trophic structure of a subtropical bay as estimated from mass-balance food web model and stable isotope analysis. **Ecological Modelling**, v. 312, p. 175–181, 2015.

DUARTE, G. a. S.; ANDREATA, J. V. Feeding habits of Achiridae and Cynoglossidae species from ribeira bay, Angra dos Reis, Rio de Janeiro, Brazil. **Bioikos**, v. 17, n. 1/2, p. 39–48, 2003.

ELLIFF, C. I.; TUTUI, S. L. D. S.; SOUZA, M. R. De; TOMÁS, A. R. G. Population structure of caitipa Mojarra (*Diapterus rhombeus*) in an estuarine system of Southeastern Brazil. **Boletim do Instituto de Pesca**, v. 39, n. 17, p. 411–421, 2013.

FRANCIS, T. B.; LEVIN, P. S.; HARVEY, C. J. The perils and promise of futures analysis in marine ecosystem-based management. **Marine Policy**, v. 35, p. 675–681, 2011.

FRERET, N. V.; VANDERLI, J. A. Diet composition of *Micropogonias Furnieri* (DESMAREST, 1823) (TELEOSTEI, SCIAENIDAE) from Ribeira Bay, Angra Dos Reis, Rio De Janeiro. **Bioikos**, v. 17, n. 1/2, p. 33–37, 2003.

FROESE, R.; BINOHLAN, C. Empirical relationships to estimate asymptotic length, length at first maturity and length at maximum yield per recruit in fishes, with a simple method to evaluate length frequency data. **Journal of Fish Biology**, v. 56, n. 4, p. 758–773, 2000.

GAY, D.; BASSANI, C.; SERGIPENSE, S. Diel variation and selectivity in the diet of *Cetengraulis edentulus* (CUVIER 1828)(ENGRAULIDAE-CLUPEIFORMES) in the Itaipu Lagoon, Niterói, Rio De Janeiro. **Atlântica**, v. 24, n. 2, p. 59–68, 2002.

GIARRIZZO, T.; SAINT-PAUL, U. Ontogenetic and seasonal shifts in the diet of the pemecou sea catfish *Sciades herzbergii* (Siluriformes: Ariidae), from a macrotidal mangrove creek in the Curuçú estuary, Northern Brazil. **Revista de Biologia Tropical**, v. 56, n. 2, p. 861–873, 2008.

KASPRZAK, P.; PADISZK, J.; KOSCHEL, R.; KRIENITZ, L.; GERVAIS, F. Chlorophyll a concentration across a trophic gradient of lakes: An estimator of phytoplankton biomass? **Limnologia**, v. 38, n. 3–4, p. 327–338, 2008.

KLEPPEL, G. S.; BURKART, C. a.; CARTER, K.; TOMAS, C. Diets of calanoid copepods on the West Florida continental shelf: Relationships between food concentration, food composition and feeding activity. **Marine Biology**, v. 127, n. 2, p. 209–217, 1996.

KOCH, V.; WOLFF, M. Energy budget and ecological role of mangrove epibenthos in the Caete estuary, North Brazil. **Marine Ecology Progress Series**, v. 228, p. 119–130, 2002.

LIRA, A. S. Aplicação de modelos tróficos em um estuário de Pernambuco: Um estudo de caso em Sir

KOCH, V.; WOLFF, M.; DIELE, K. Comparative population dynamics of four fiddler crabs (Ocypodidae, genus *Uca*) from a North Brazilian mangrove ecosystem. **Marine Ecology Progress Series**, v. 291, n. April, p. 177–188, 2005.

KRUMME, U.; KEUTHEN, H.; BARLETTA, M.; SAINT-PAUL, U.; VILLWOCK, W. Resuspended Intertidal Microphytobenthos As Major Diet Component of Planktivorous Atlantic Anchoveta *Cetengraulis Edentulus* (Engraulidae) From Equatorial Mangrove Creeks. **Ecotropica-Bonn**, v. 14, p. 121–128, 2008.

LAURETTA, M.; CAMP, E.; PINE, W.; FRAZER, T. Catchability model selection for estimating the composition of fishes and invertebrates within dynamic aquatic ecosystems. **Canadian Journal of Fisheries and Aquatic Sciences**, v. 70, n. August 2015, p. 381–392, 2013.

LE QUESNE, W. J. F.; JENNINGS, S. Predicting species vulnerability with minimal data to support rapid risk assessment of fishing impacts on biodiversity. **Journal of Applied Ecology**, v. 49, n. 1, p. 20–28, 2012.

LESSA, R.; DUARTE-NETO, P.; MORIZE, E.; MACIEL, R. Otolith microstructure analysis with OTC validation confirms age overestimation in Atlantic thread herring *Opisthonema oglinum* from north-eastern Brazil. **Journal of Fish Biology**, v. 73, n. 7, p. 1690–1700, 2008.

LOUIS, M. Reproduction de *Bairdiella* dans roncus les mangroves ( Antilles et croissance ( Poisson Scianidae ) de Guadeloupe françaises )( 1 ). **Revista Hydrobiologia Tropical**, v. 18, n. 1, p. 61–72, 1985.

MENDONÇA, M. C. F. B. de. Autoecologia do camorim, *Centropomus undecimalis* (BLOCH , 1792), (PERCIFORMES : CENTROPOMIDAE) em ambiente hipersalino em Galinhos, RN, Brasil. **Universidade Federal de São Carlos**, p. 145, 2004.

MILLS, E. The structure and dynamics of shelf and slope ecosystems off the northeast coast of North America. In: TENORE, K.; COULL, B. (Ed.). **Marine Benthic dynamics**. Columbia, South Carolina: South Carolina Press, 1980. p. 24–27.

MONTEIRO, D. P.; GIARRIZZO, T.; ISAAC, V. Feeding ecology of juvenile dog snapper *Lutjanus jocu* (Bloch and Shneider, 1801) (Lutjanidae) in intertidal mangrove

LIRA, A. S. Aplicação de modelos tróficos em um estuário de Pernambuco: Um estudo de caso em Sir

creeks in Curuçú estuary (Northern Brazil). **Brazilian Archives of Biology and Technology**, v. 52, n. 6, p. 1421–1430, 2009.

MORIARTY, D. J. W.; BARCLAY, M. C. Carbon and nitrogen content of food and the assimilation efficiencies of penaeid prawns in the Gulf of Carpentaria. **Marine and Freshwater Research**, v. 32, n. 2, p. 245–251, 1981.

NEWELL, R. I. E.; MARSHALL, N.; SASEKUMAR, A.; CHONG, V. C. Relative importance of benthic microalgae, phytoplankton, and mangroves as sources of nutrition for penaeid prawns and other coastal invertebrates from Malaysia. **Marine Biology**, v. 123, n. 3, p. 595–606, 1995.

NICHOLS, F. H. Sediment turnover by a deposit-feeding polychaete. **Limnology and Oceanography**, v. 19, n. 6, p. 945–950, 1974.

NORDHAUS, I. Feeding ecology of the semi-terrestrial crab *Ucides cordatus cordatus* (Decapoda: Brachyura) in a mangrove forest in northern Brazil. **ZMT Contributions**, v. 18, p. i–xii, 1-198, 2004.

OLIVEIRA, A.; PINTO, T. K.; SANTOS, D. P. D.; INCAO, F. D. Dieta natural do siri-azul *Callinectes sapidus* (Decapoda, Portunidae) na região estuarina da Lagoa dos Patos, Rio Grande, Rio Grande do Sul, Brasil. **Iheringia, Sér. Zool.**, v. 96, n. 3, p. 305–313, 2006.

OPITZ, S. Trophic interactions in caribbean coral reefs I. [s.l: s.n.]v. 43

OTEGUI, M. B. P.; BLANKENSTEYN, A.; PAGLIOSA, P. R. Population structure, growth and production of *Thoracophelia furcifera* (Polychaeta: Opheliidae) on a sandy beach in Southern Brazil. **Helgoland Marine Research**, v. 66, n. 4, p. 479–488, 2012.

PALOMARES, M. L. D.; PAULY, D. Predicting food consumption of fish populations as functions of mortality, food type, morphometrics, temperature and salinity. **Marine and Freshwater Research**, v. 49, n. 5, p. 447, 1998.

PARSONS, T.; TAKAHASHI, M.; HARGRAVE, B. Biological oceanographical processes. New York: Pergamon Press, 1977.

PAULY, D. On the Interrelationships between Natural Mortality, Growth Parameters, and

LIRA, A. S. Aplicação de modelos tróficos em um estuário de Pernambuco: Um estudo de caso em Sir

Mean Environmental Temperature in 175 Fish Stocks. **Journal du Conseil**, v. 39, n. 2, p. 175–192, 1980.

PAULY, D. Algunos métodos simples para la evaluación de recursos pesqueros tropicales. [s.l.: s.n.]v. 234

PAULY, D.; CHRISTENSEN, V. Primary production required to sustain global fisheries. **Nature**, v. 374, n. 6519, p. 255–257, 1995.

PAULY, D.; PALOMARES, M. L. D.; SORIANO-BARTZ, M. Improved construction, parameterisation and interpretation of steady-state ecosystem models. In: VILLY, C.; PAULY, D. (Ed.). **Trophic models of aquatic ecosystems**. [s.l.] International Center for Living Aquatic Resources Management - ICLARM, 1993. p. 403.

RAMOS, J. A. A.; BARLETTA, M.; DANTAS, D. V.; LIMA, A. R. A.; COSTA, M. F. Trophic niche and habitat shifts of sympatric Gerreidae. **Journal of Fish Biology**, v. 85, n. 5, p. 1446–1469, 2014.

RESGALLA, C. J.; PIOVEZAN, A. Fisiologia alimentar do berbigão *Anomalocardia brasiliana* ( GMELIN , 1791 ) ( MOLLUSCA : BIVALVIA ). **Atlântica**, v. 31, n. 1, p. 69–78, 2009.

REZENDE, S. D. M.; FERREIRA, B. P. Age, growth and mortality of dog snapper *Lutjanus jocu* (Bloch & Schneider, 1801) in the northeast coast of Brazil. **Brazilian Journal of Oceanography**, v. 52, n. 2, p. 107–121, 2004.

SANTANA, F. M.; MORIZE, E.; CLAVIER, J.; LESSA, R. Otolith micro- and macrostructure analysis to improve accuracy of growth parameter estimation for white mullet *Mugil curema*. **Aquatic Biology**, v. 7, n. 3, p. 199–206, 2009.

SANTOS, A. C. de A.; RODRIGUEZ, F. N. de C. Ocorrência e alimentação do baiacu *Sphoeroides testudineus* (Actinopterygii – Tetraodontiformes ) na margem oeste da Baía de Todos os Santos, Bahia, Brasil. **Sitirntibus série Ciências Biológicas**, v. 11, n. 1, p. 31–36, 2011.

SANTOS, P. J. P. Population dynamics and production of *Scolecopsis gaucha* (Polychaeta, Spionidae) on the sandy beaches of southern Brazil. **Marine Ecology Progress Series**,

LIRA, A. S. Aplicação de modelos tróficos em um estuário de Pernambuco: Um estudo de caso em Sir

v. 110, n. 2–3, p. 159–166, 1994.

SANTOS, R. Tamanho de primeira maturação, idade e crescimento de *Micropogonias furnieri* (Desmarest, 1823) na Baía de Ubatuba, SP. **Universidade Federal Rural do Rio de Janeiro**, p. 60, 2015.

SCHNETZER, A.; STEINBERG, D. K. Natural diets of vertically migrating zooplankton in the Sargasso Sea. **Marine Biology**, v. 141, n. 1, p. 89–99, 2002.

SCHWAMBORN, R. Influence of mangroves on community structure and nutrition of macrozooplankton in northeast brasil. 1997. Center for Tropical Marine Ecology, Bremen, 1997.

SERGIPENSEL, S.; CARAMASCHI, E. P.; SAZIMA, I. Morfologia e hábitos alimentares de duas espécies de Engraulidae (Teleostei, Clupeiformes) na Baía de Sepetiba, Rio de Janeiro. **Brazilian Journal of Oceanography**, v. 47, n. 2, p. 173–188, 1999.

SILVA, J. P. do C.; SANTOS, R. da S.; COSTA, M. R. da; ARAÚJO, F. G. Parâmetros de crescimento e mortalidade de *Eucinostomus argenteus* (Baird & Girard, 1854) capturados no manguezal de Guaratiba, Baía de Sepetiba, RJ. **Boletim do Instituto de Pesca**, v. 40, n. 4, p. 657–667, 2014.

SILVA, M. H. da. Estrutura e produtividade da comunidade fitoplanctônica de um estuário tropical (Sirinhaém, Pernambuco, Brasil). p. 170, 2009.

SILVANO, R. A. M. Feeding habits and interspecific feeding associations of *Caranx latius* (Carangidae) in a subtropical reef. **Environmental Biology of Fishes**, v. 60, n. 4, p. 465–470, 2001.

SIMON, L. N.; RAFFAELLI, D. A Trophic Model Of The Cameroon Estuary Mangrove With Simulations Of Mangrove Impacts. **International Journal Of Scientific & Technology Research**, v. 5, n. 8, 2016.

SOUZA-CONCEICAO, J. M.; SCHWINGEL, P. R. Age and growth of *Cetengraulis edentulus* (Clupeiformes: Engraulidae) in a subtropical bight of Southern Coast Brazil. **Zoologia**, v. 28, n. 3, p. 297–304, 2011.



LIRA, A. S. Aplicação de modelos tróficos em um estuário de Pernambuco: Um estudo de caso em Sir

SOUZA, J. R. B. De; BORZONE, C. a. Population dynamics and secondary production of *Euzonus furciferus* Ehlers (Polychaeta, Opheliidae) in an exposed sandy beach of Southern Brazil. **Revista Brasileira de Zoologia**, v. 24, n. 4, p. 1139–1144, 2007.

SPILMONT, N.; BOUCHER, G.; DENIS, L.; HUBAS, C.; JANQUIN, M.; RAUCH, M.; DAVOULT, D. Annual budget of benthic production in Mont Saint-Michel Bay considering cloudiness , microphytobenthos migration , and variability of respiration rates with tidal conditions. v. 29, p. 2280–2285, 2009.

TZEEK-TUZ, J.; BONILLA-GÓMEZ, J. L.; BADILLO-ALEMÁN, M.; CHIAPPA-CARRARA, X. Length-weight relationship and parameters of growth for the checkered puffer *Sphoeroides testudineus* from a karstic tropical coastal lagoon: La Carbonera, Yucatan, Mexico. **Journal of Applied Ichthyology**, v. 28, n. 5, p. 859–860, 2012.

UNDERWOOD, G. J. C.; KROMKAMP, J. Primary Production by Phytoplankton and Microphytobenthos in Estuaries. **Advances in Ecological Research**, v. 29, n. C, p. 93–153, 1999.

VASCONCELOS FILHO, A. de L.; NEUMANN-LEITÃO, S.; ESKINAZI-LEÇA, E.; OLIVEIRA, A. M. E. Hábitos alimentares de peixes consumidores secundários do Canal de Santa Cruz, Pernambuco, Brasil. **Tropical Oceanography Online**, v. 38, n. 2, p. 121–128, 2010.

VASCONCELOS FILHO, A. de L.; SILVA, K. C.; ACIOLI, F. D. Hábitos alimentares de *Sphoeroides testudineus* (Linnaeus, 1758) (Teleostei: Tetraodontidae), no canal de Santa Cruz Itamaraca-Pe. **Tropical Oceanography Online**, v. 26, n. 1, p. 145–157, 1998.

VASCONCELOS FILHO, a L.; NEUMANN-LEITÃO, S.; ESKINAZI-LEÇA, E.; PORTO-NETO, F. F. Hábitos alimentares de consumidores primários da ictiofauna do sistema estuarino de Itamaracá (Pernambuco - Brasil). **Revista Brasileira de Engenharia de Pesca**, v. 4, n. 1, p. 21–31, 2009.

VENDEL, A. L.; CHAVES, P. D. T. D. C. Alimentação de *Bairdiella ronchus* (Cuvier) (Perciformes, Sciaenidae) na Baía de Guaratuba, Paraná, Brasil. **Revista Brasileira de Zoologia**, v. 15, n. 2, p. 297–305, 1998.

VIANA, A. P.; LUCENA-FRÉDOU, F.; MÉNARD, F.; FRÉDOU, T.; FERREIRA, V.;

LIRA, A. S. Aplicação de modelos tróficos em um estuário de Pernambuco: Um estudo de caso em Sir

LIRA, A. S.; LE LOC'H, F. Length–weight relations of 70 fish species from tropical coastal region of Pernambuco, Northeast Brazil. **Acta Ichthyologica et Piscatoria**, v. 46, n. 3, p. 271–277, 2016.

VILLANUEVA, M. C. Contrasting tropical estuarine ecosystem functioning and stability: A comparative study. **Estuarine, Coastal and Shelf Science**, v. 155, p. 89–103, 2015.

WALTERS, C.; MARTELL, S. J. .; MAHMOUDI, B. Ecosim model for exploring ecosystem management options for the Gulf of Mexico: implications of including multistanza life history models for policy predictions. **Bulletin of Marine Science**, v. 83, n. 1, p. 251–271, 2008.

WOLFF, M.; KOCH, V.; ISAAC, V. A Trophic Flow Model of the Caeté Mangrove Estuary (North Brazil) with Considerations for the Sustainable Use of its Resources. **Estuarine, Coastal and Shelf Science**, v. 50, n. 6, p. 789–803, 2000.

ZETINA-REJÓN, M. J.; CABRERA-NERI, E.; LÓPEZ-IBARRA, G. A.; ARCOS-HUITRÓN, N. E.; CHRISTENSEN, V. Trophic modeling of the continental shelf ecosystem outside of Tabasco, Mexico: A network and modularity analysis. **Ecological Modelling**, v. 313, p. 314–324, 2015.